



# Signature

*Artiste*<sup>®</sup>  
Signature  
Collection  
Designer Concrete



Over the years, Nuvoco has achieved excellence and great acclaim in almost every endeavour, through customer centric innovations that help shape all architectural dreams into concrete forms. With integrity, collaboration, care and innovation lying in the heart of its core values, the brand has evolved to become one of the leading building material companies of the nation.

Nuvoco is dedicated to bringing the best solution to every construction requirement. Nuvoco's range of products offer aesthetic appeal, convenience of use and excellence of performance. They make the construction process simpler, easier and more efficient for all its consumers.

To further this process of safer, smarter and sustainable constructions, Nuvoco now brings to you the Artiste Signature Collection in the concrete category. Raising the benchmark of landscaping, this collection is sure to shape a better and beautiful new world.

*Artiste*®  
Signature  
Collection  
Designer Concrete

---

Unique patterns, splendid textures and pre-eminent designs – every offering of the Artiste Signature Collection has been specially crafted for you, keeping your refined taste in mind. Rest assured, the exquisiteness and the class that the collection oozes, will convert your dream abode from a mere concrete structure to a masterpiece!

The Artiste Signature Collection, inspired from nature and natural stones, comes in two variants – International Designs and Celebrity Designs created by none other than the well-acclaimed interior designer Gauri Khan.

---



GAURI KHAN  
DESIGNS

G a u r i K h a n

*Gauri Khan*  
Gauri Khan  
Celebrity Interior Designer

Make your dream designs  
come to life with Gauri Khan's  
creation for the Artiste

Artiste

# OSCILLATE PATTERN

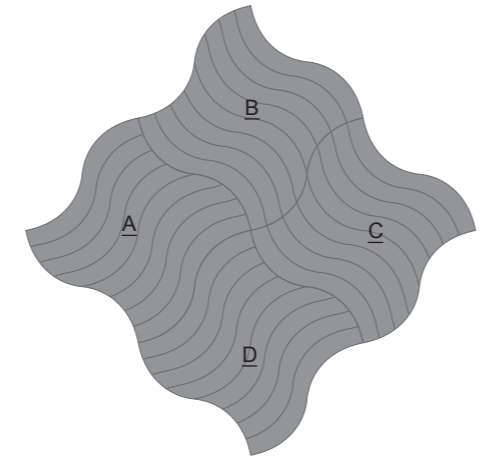
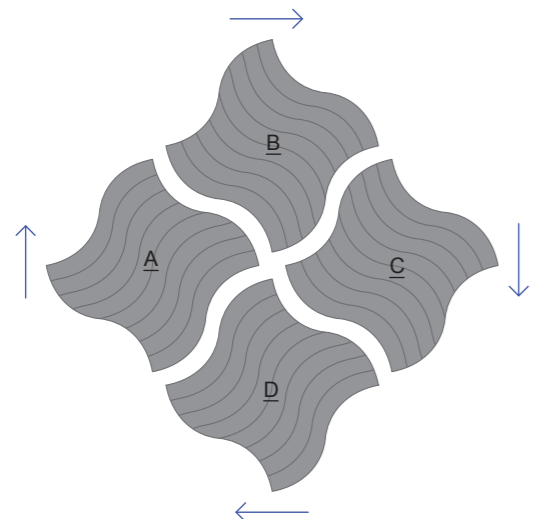
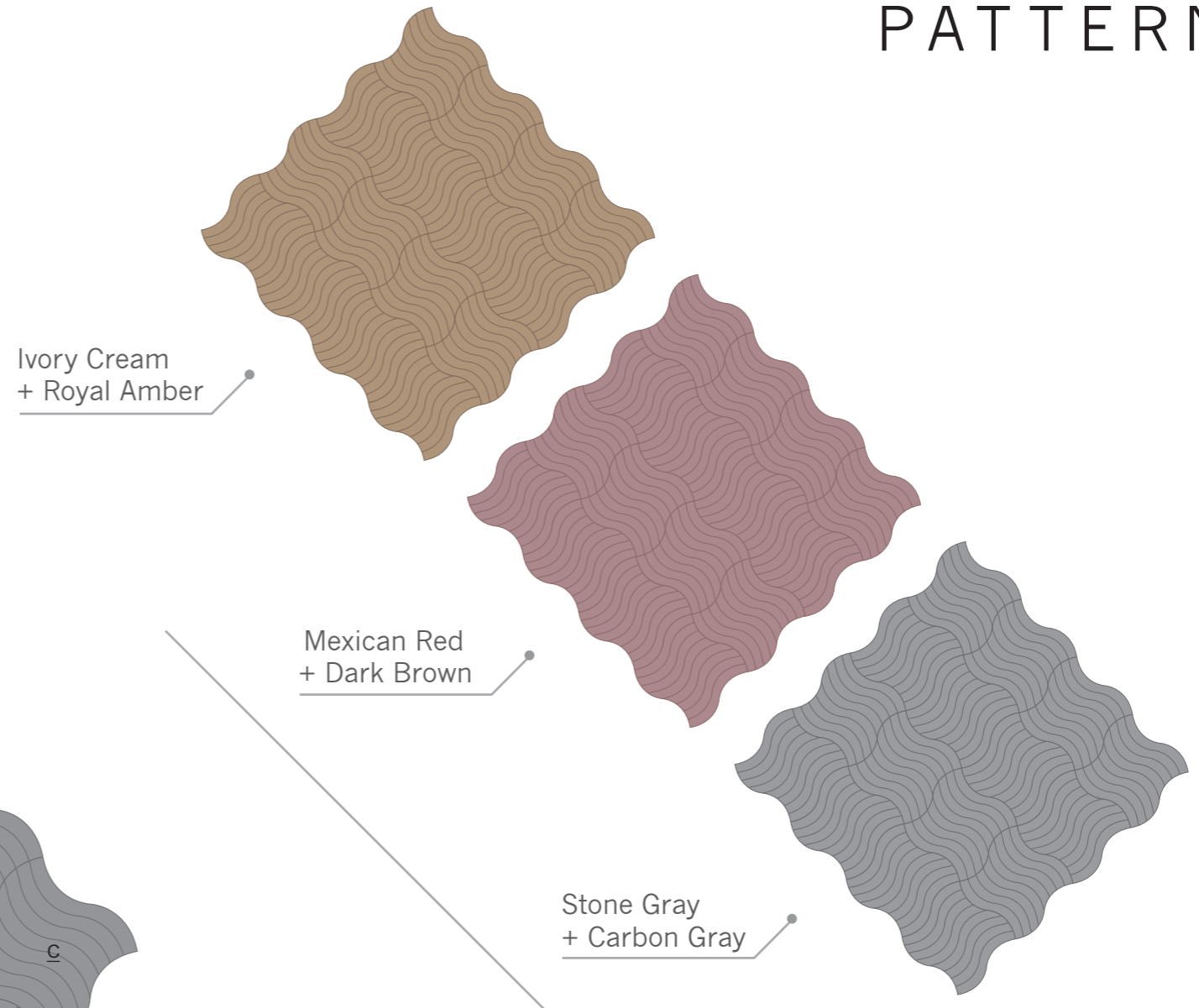
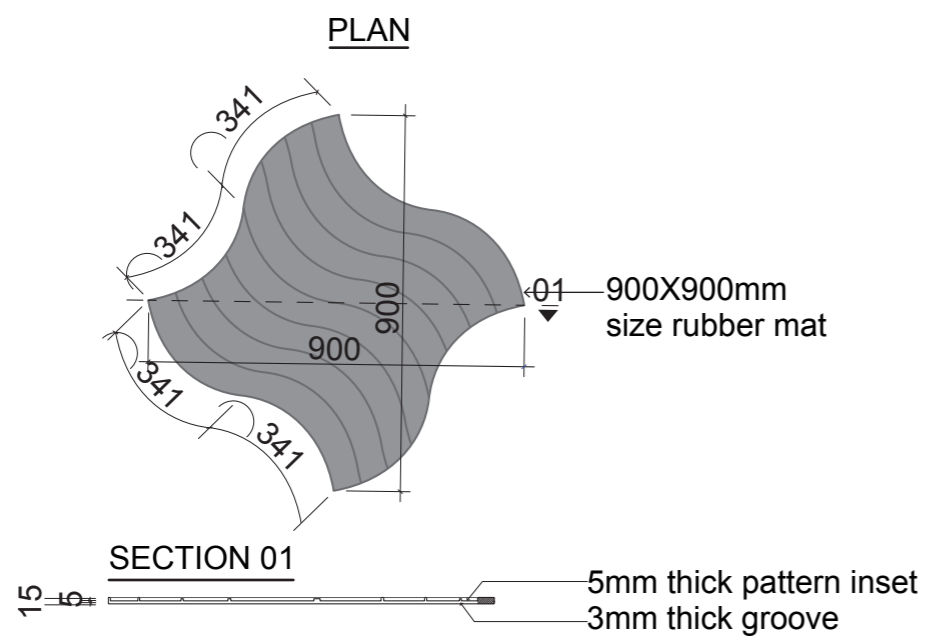

Rotation – alternate ascending & alternate descending order

Available in 25 different colours



S t o n e G r a y + C a r b o n G r a y

Stone  
Summit

# COMBER PATTERN

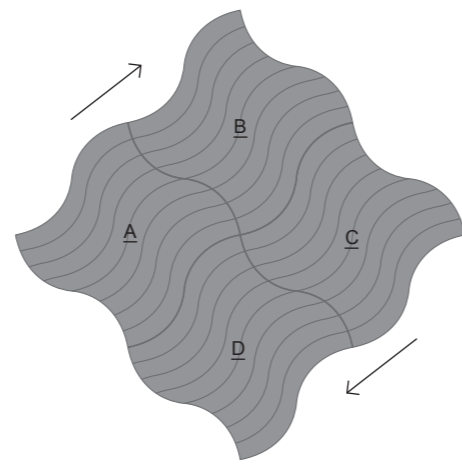
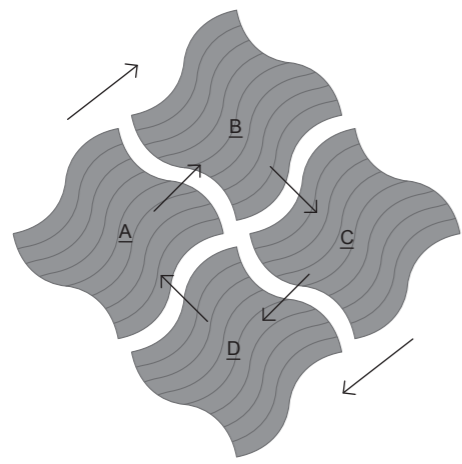
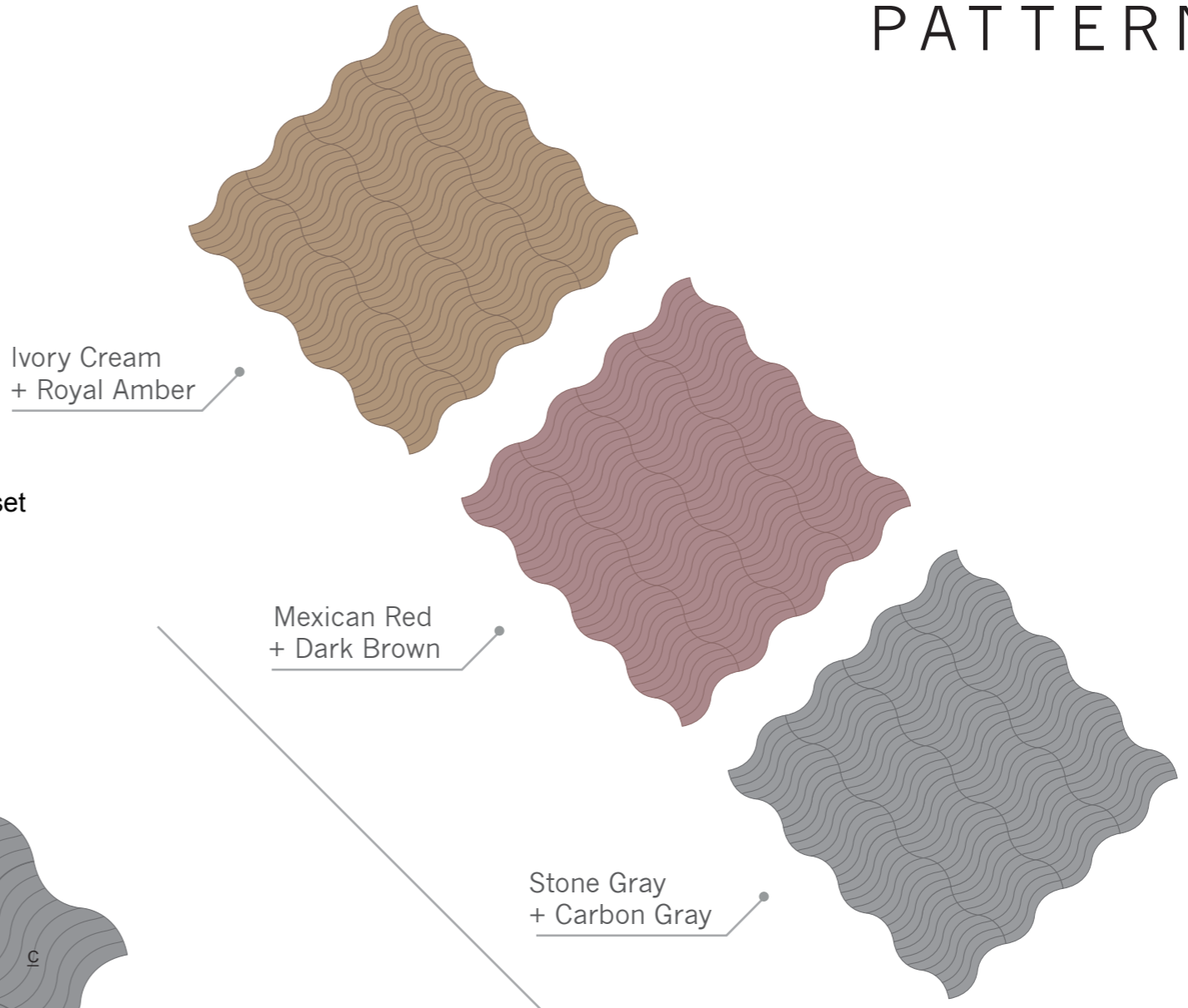
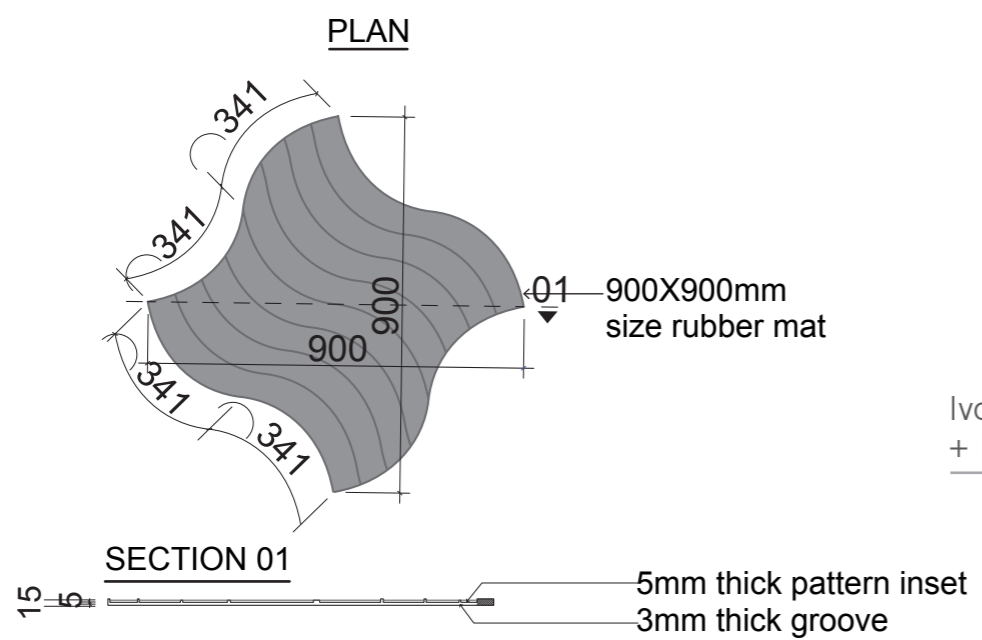

Rotation – alternate ascending & alternate descending order

Available in 25 different colours





S t o n e G r a y + C a r b o n G r a y

Stone  
Carbon  
Gray

# DRIBBLE PATTERN

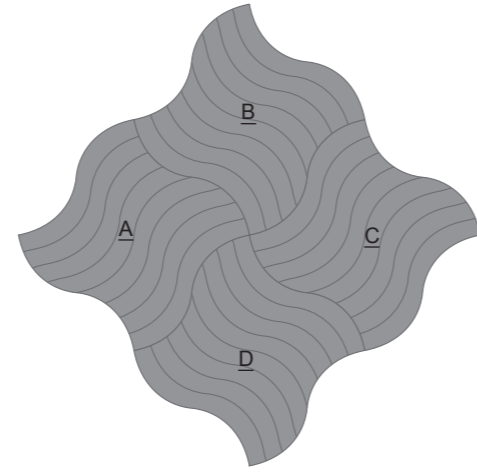
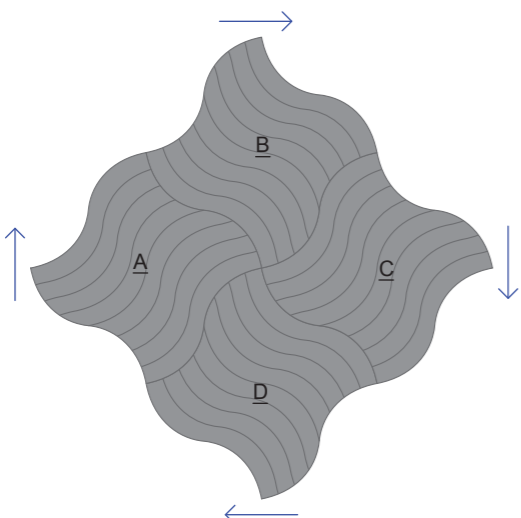
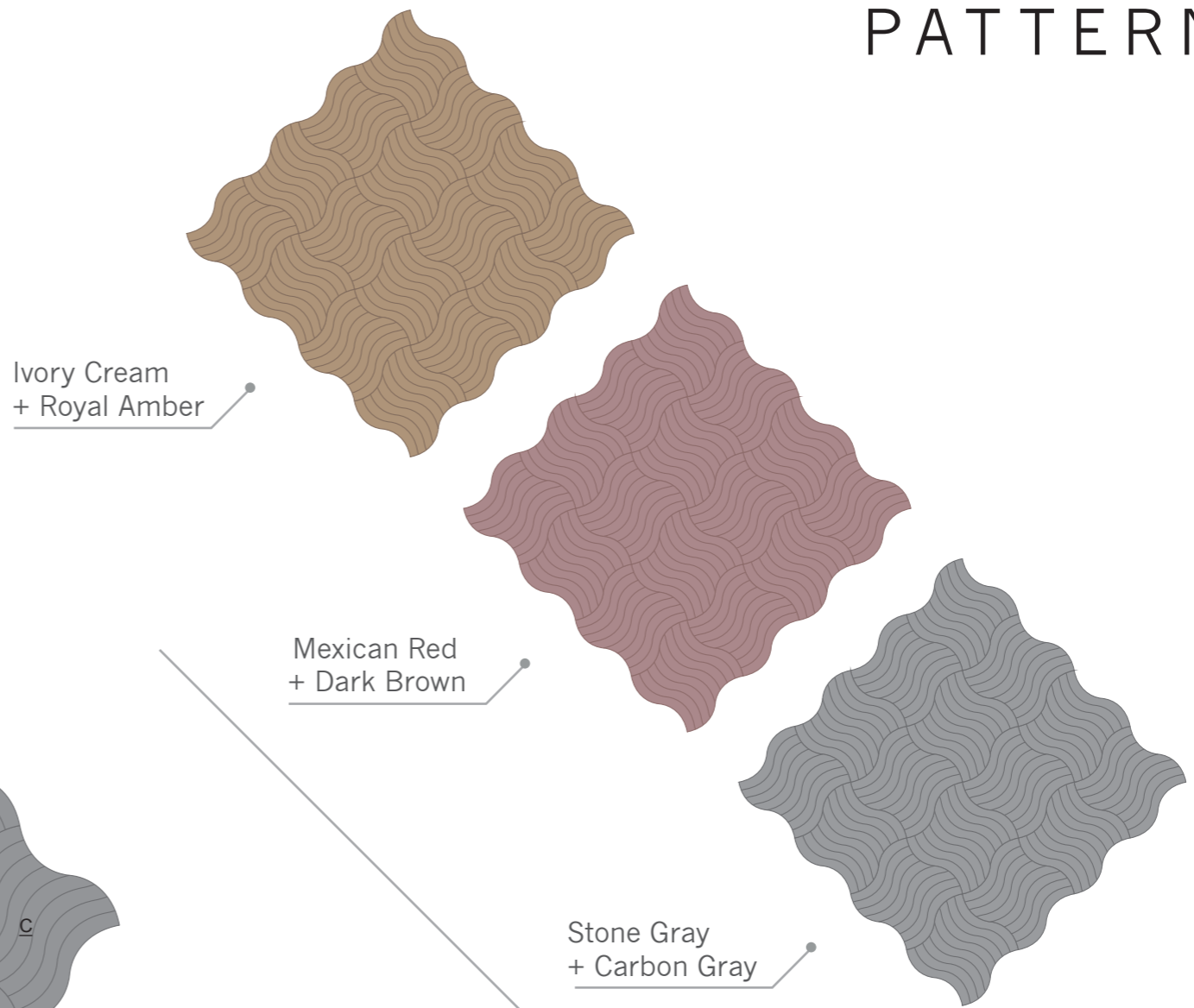
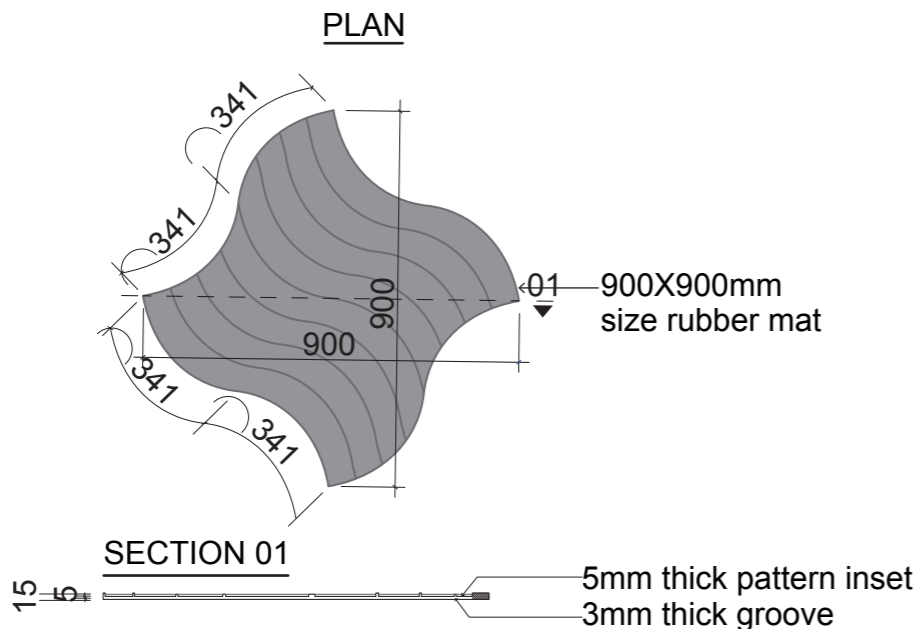

Rotation – alternate ascending & alternate descending order

Available in 25 different colours



# SPIN

Stone Gray + Carbon Gray

# FLUX PATTERN

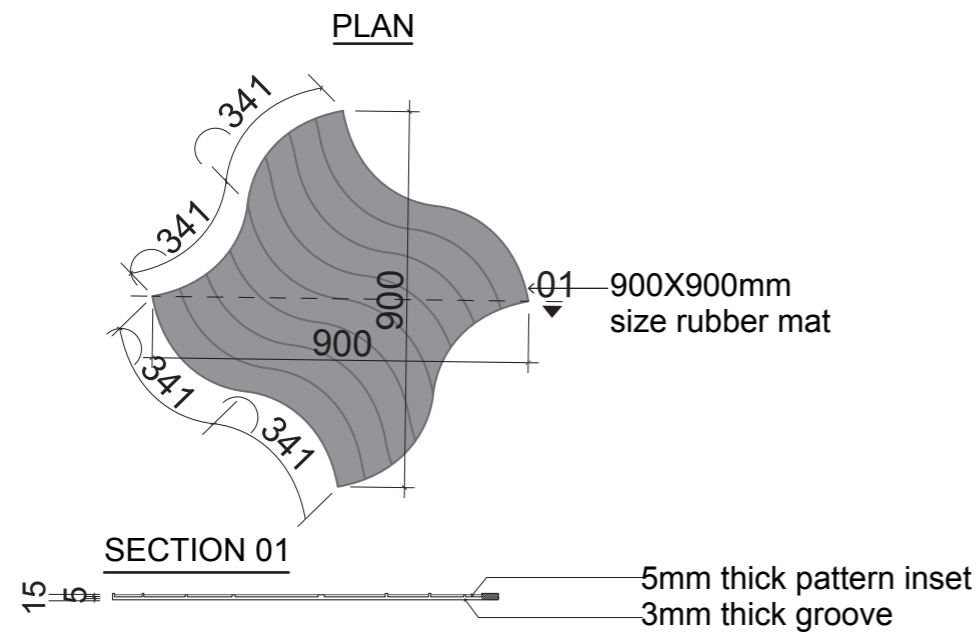

Creamy Buff  
+ Golden Amber

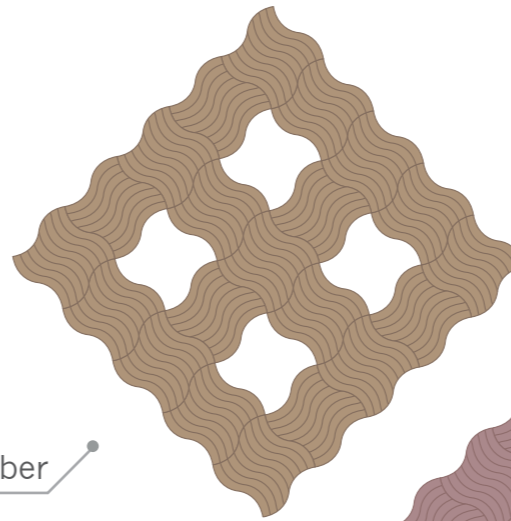

Tile Red  
+ Dark Brown

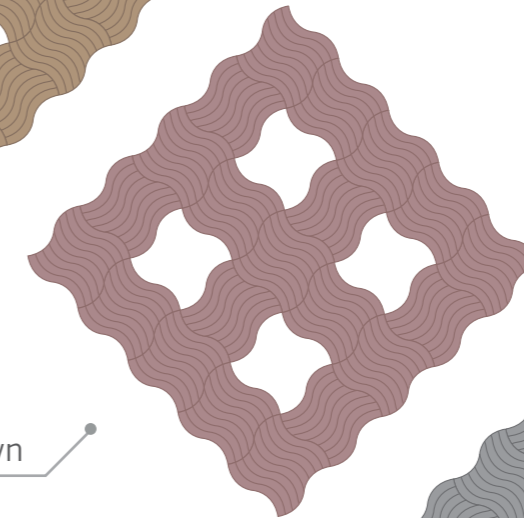

Classic Gray  
+ Charcoal Gray

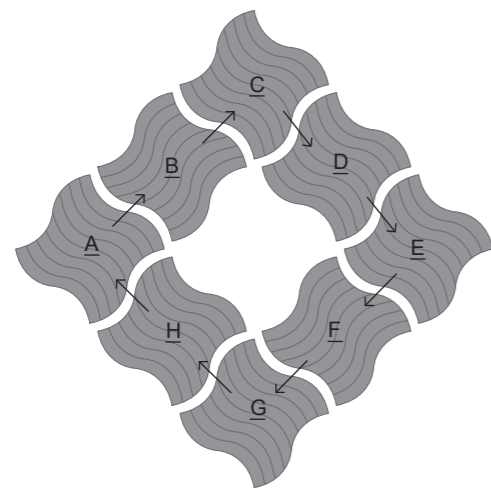
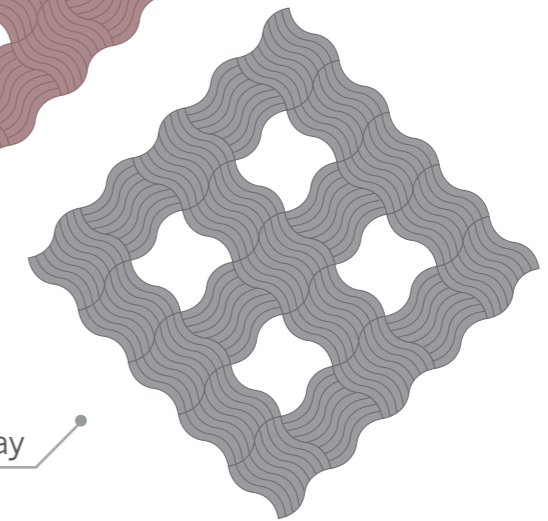

Method 01  
Showing the interlocking

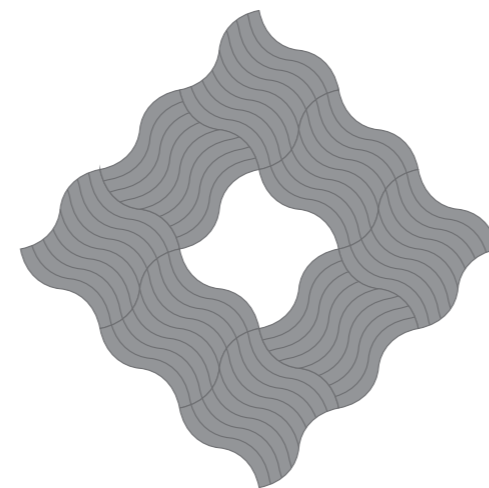

Method 02  
Showing the tessellation

Rotation – alternate ascending & alternate descending order

Available in 25 different colours

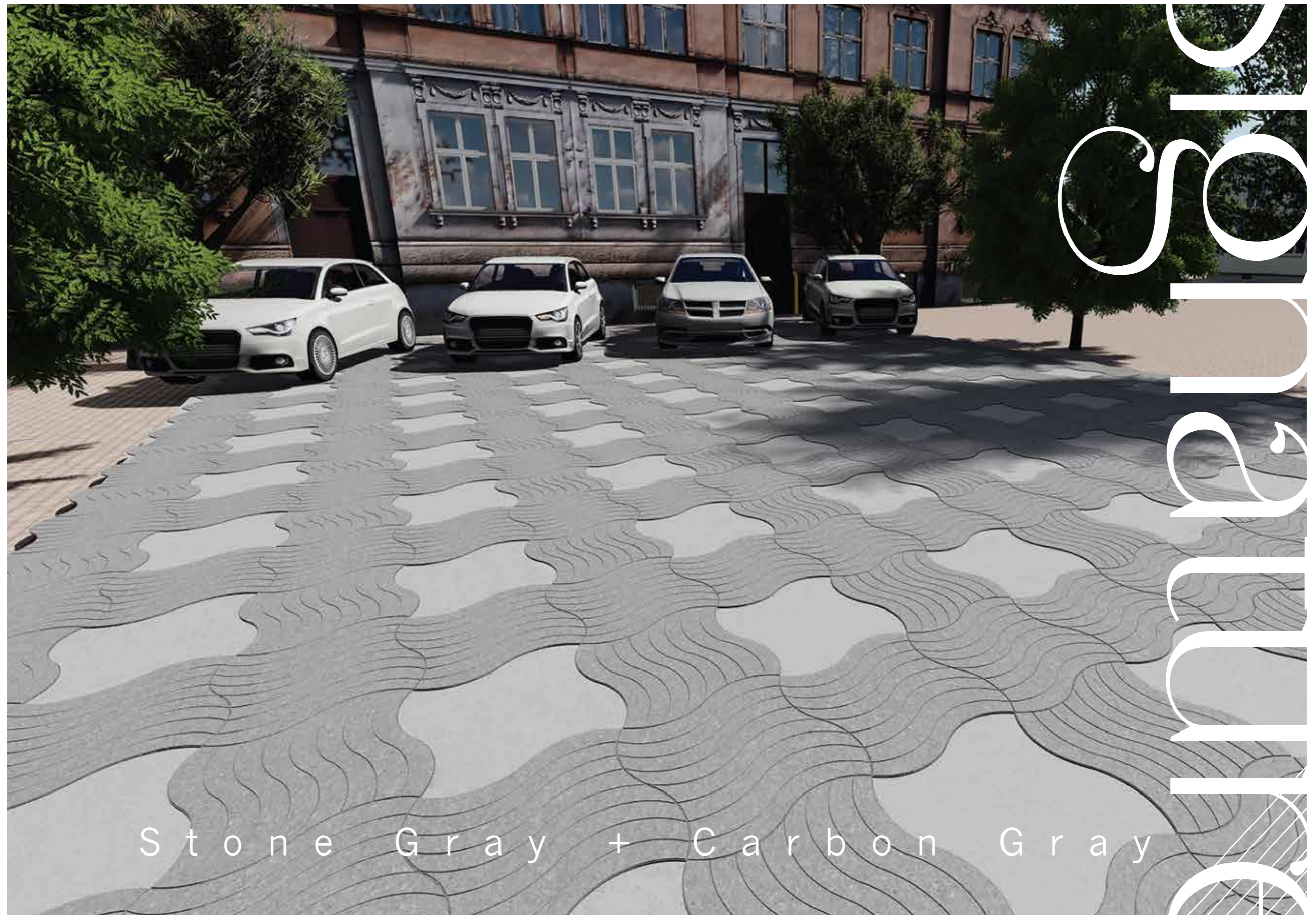

Stone Gray + Carbon Gray

SO  
LI  
S  
M  
E

# TWIRL PATTERN

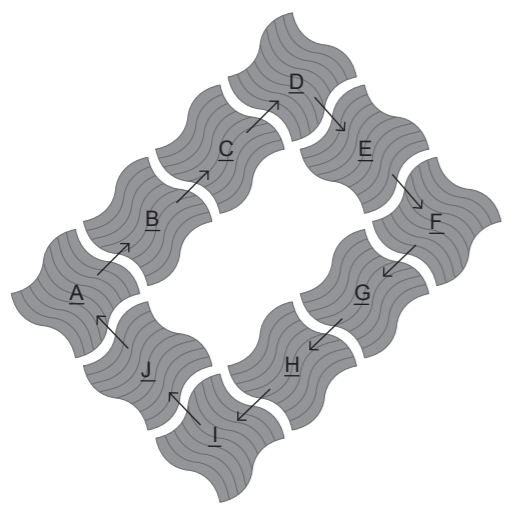
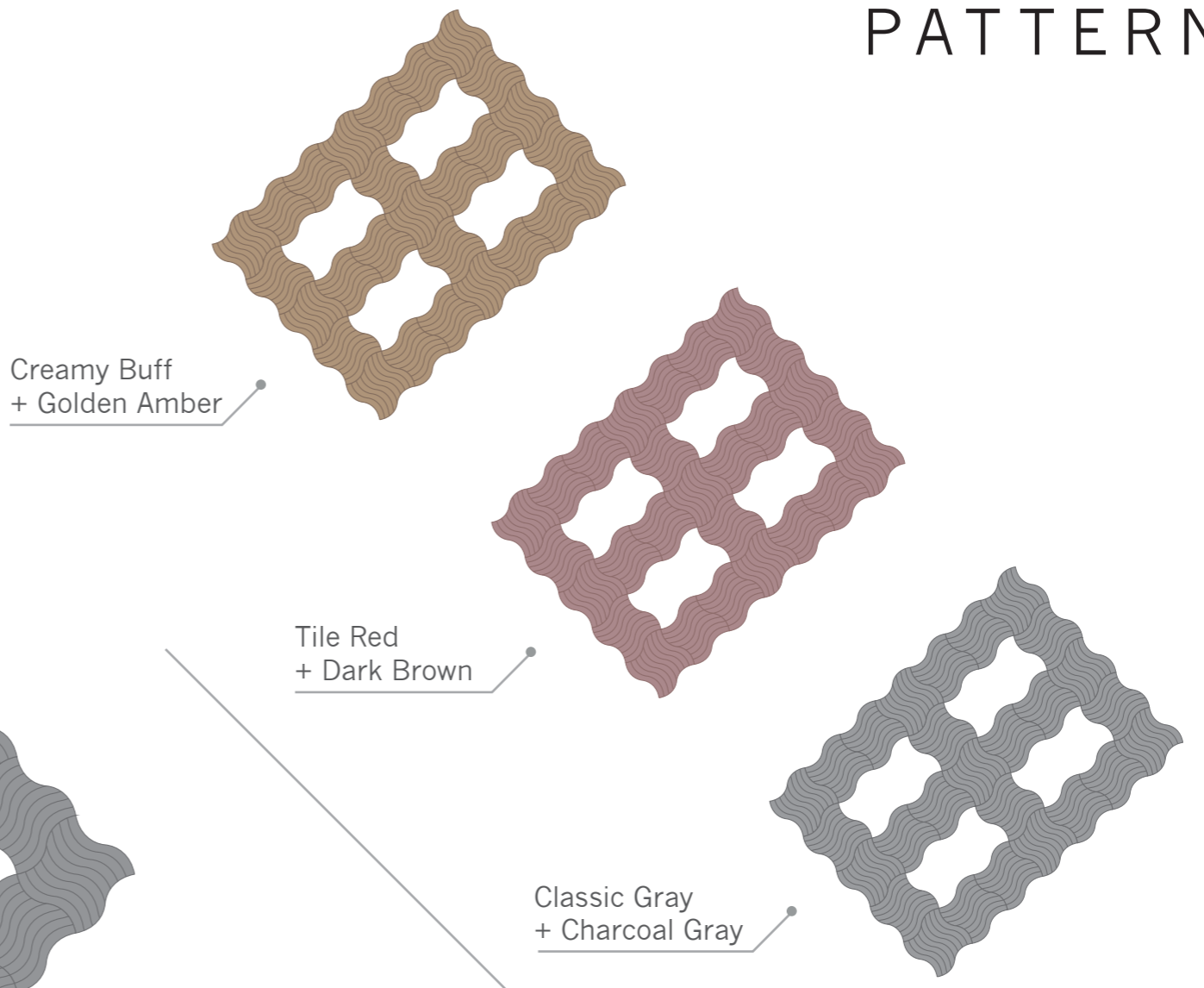
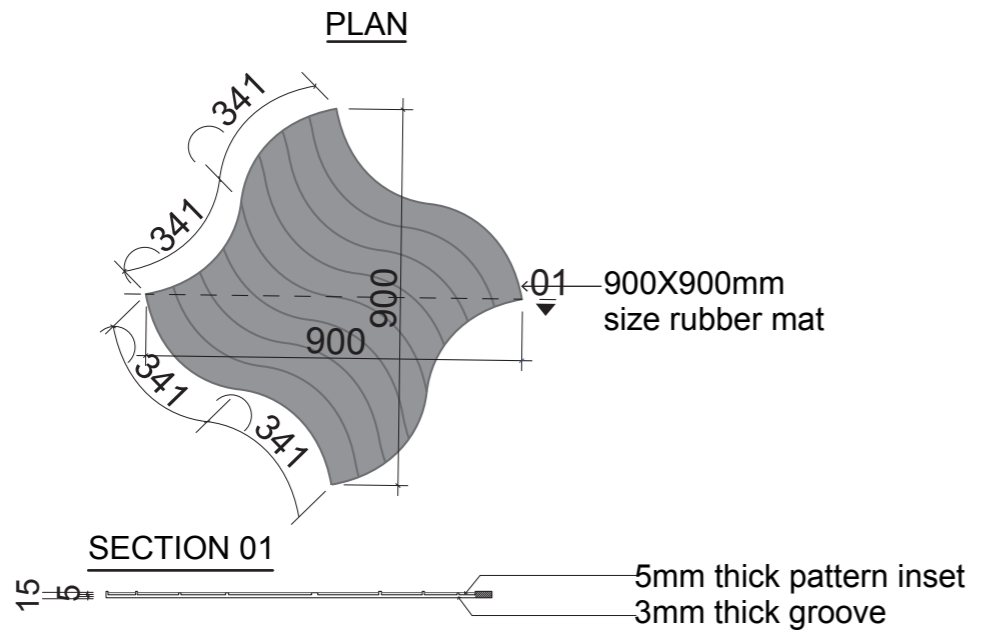

Method 01  
Showing the interlocking

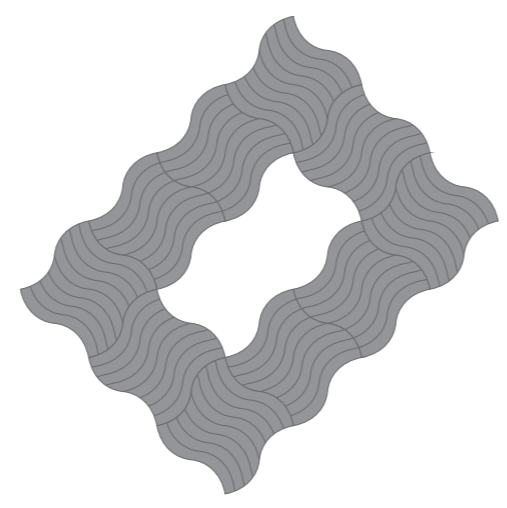

Method 02  
Showing the tessellation

Rotation – alternate ascending & alternate descending order

Available in 25 different colours



S t o n e   G r a y   +   C a r b o n   G r a y

SOLIS

# INCLINED PATTERN

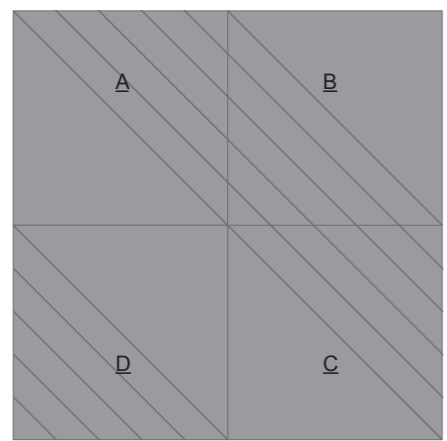
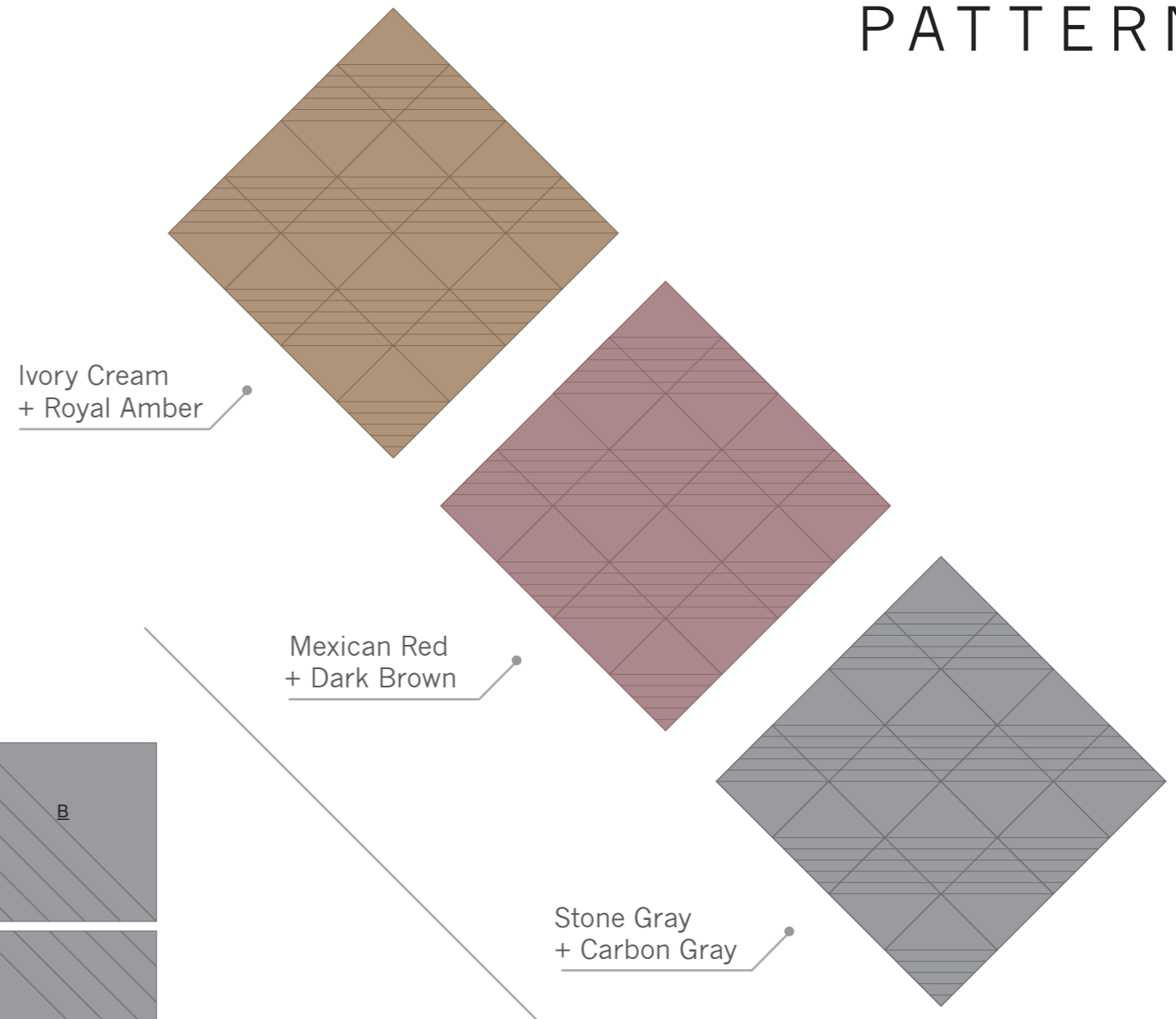
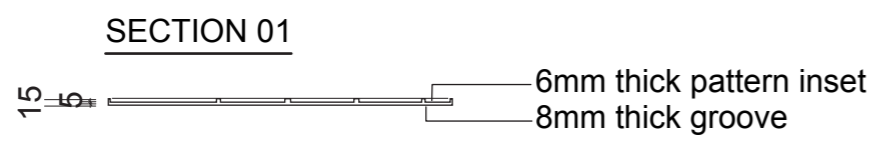
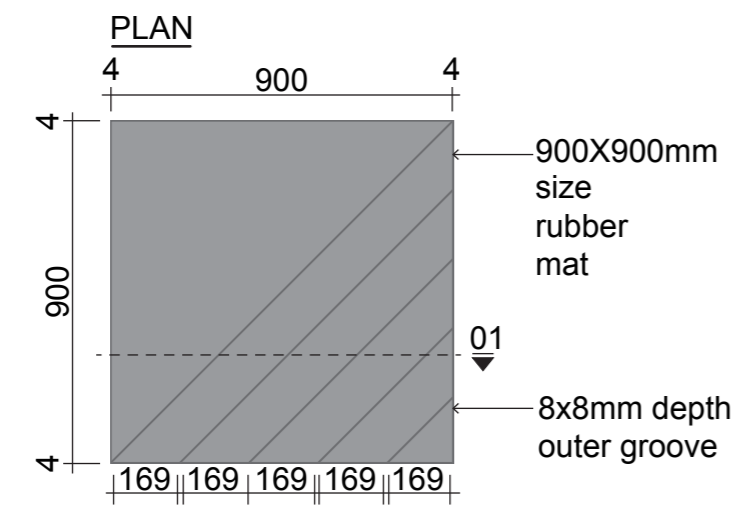

Method 01  
Showing the interlocking

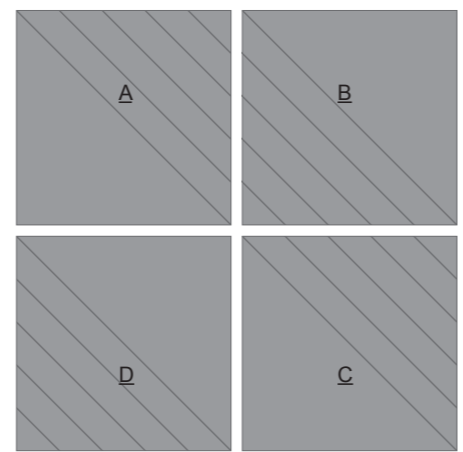

Method 02  
Showing the tessellation

Rotation – alternate ascending & alternate descending order

Available in 25 different colours



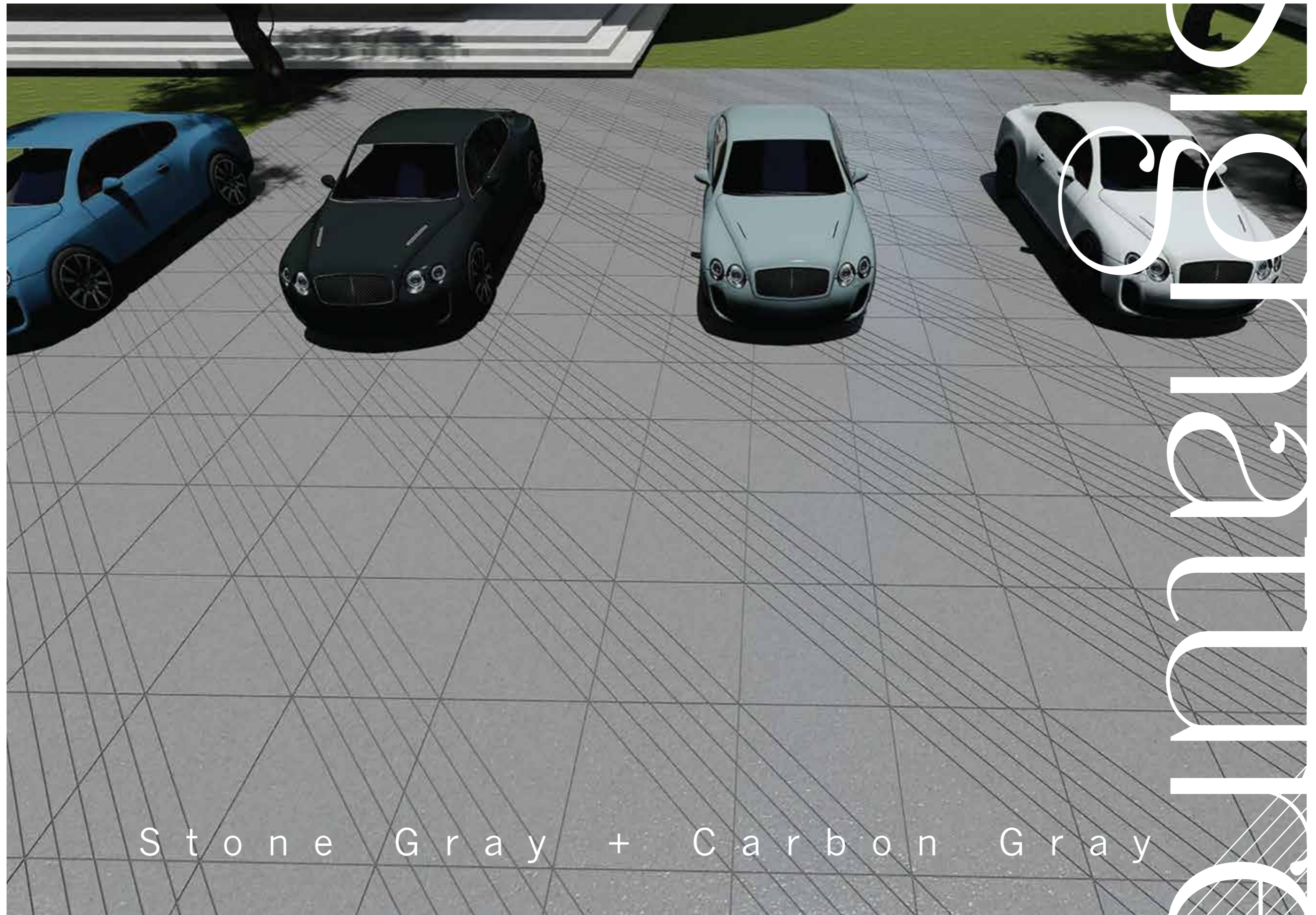

S t o n e   G r a y   +   C a r b o n   G r a y

# RIVET LINES

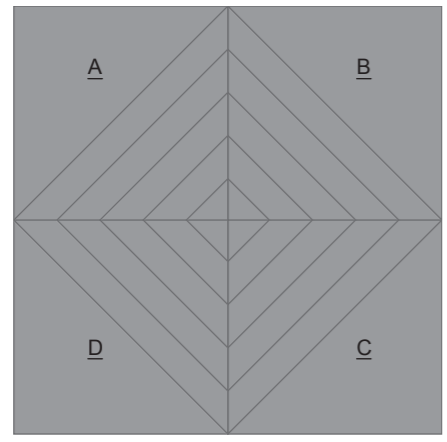
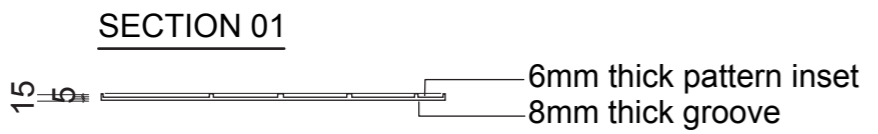
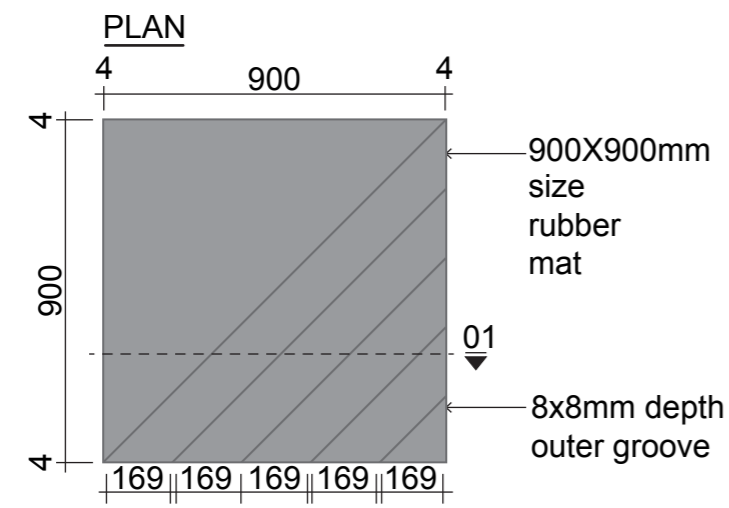

Method 01  
Showing the interlocking

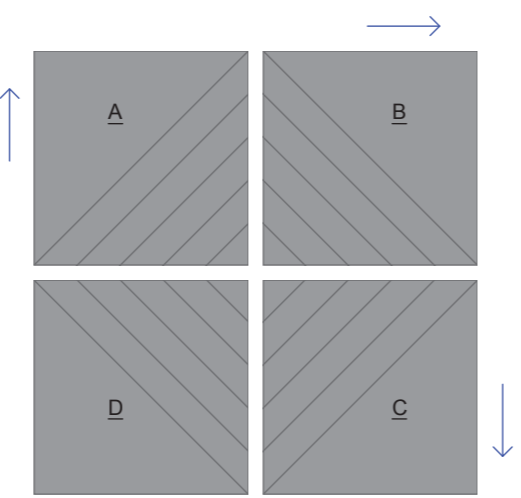

Method 02  
Showing the tessellation

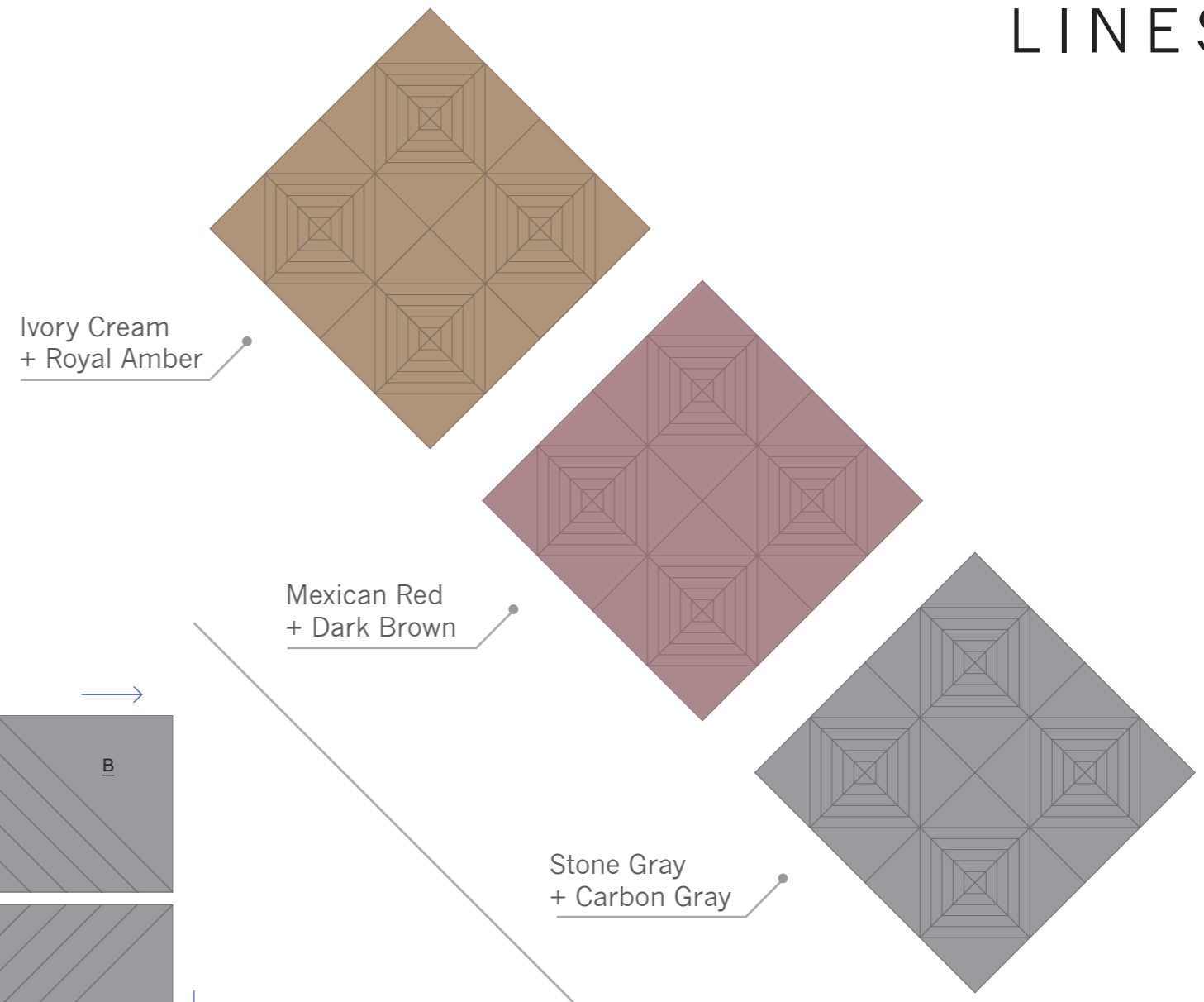

Rotation – alternate ascending & alternate descending order

Available in 25 different colours



Stone Gray + Carbon Gray

SOLAR

# SLANT SKEW

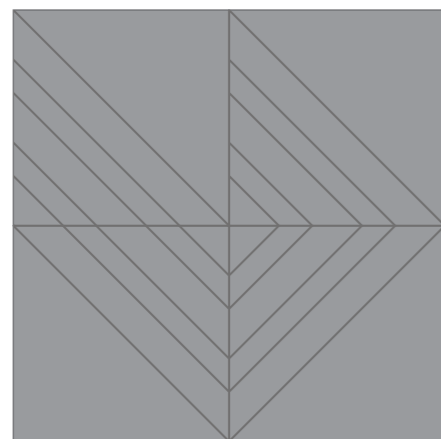
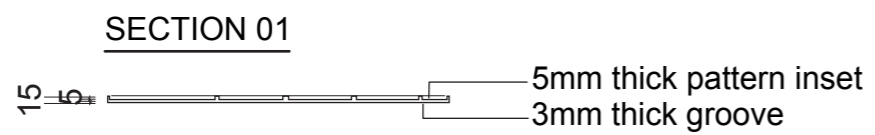
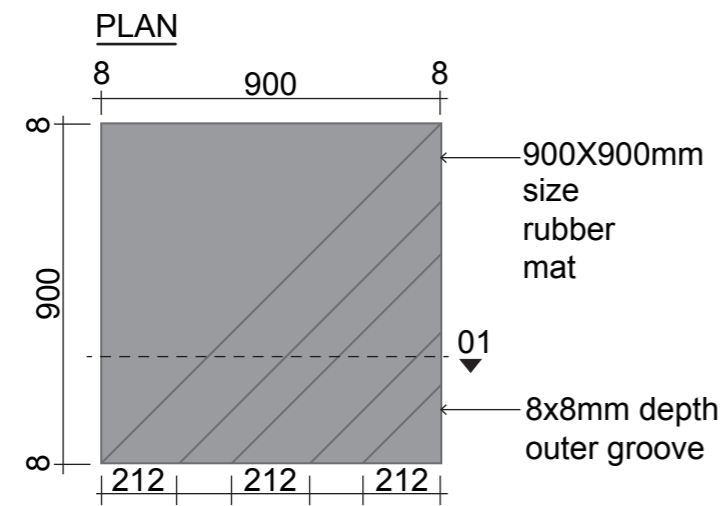

Method 01  
Showing the interlocking

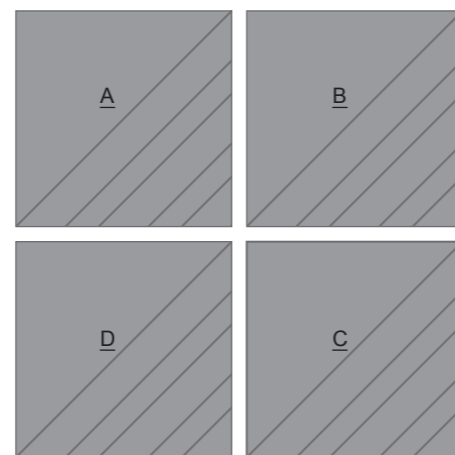

Method 02  
Showing the tessellation

Ivory Cream  
+ Royal Amber

Mexican Red  
+ Dark Brown

Stone Gray  
+ Carbon Gray

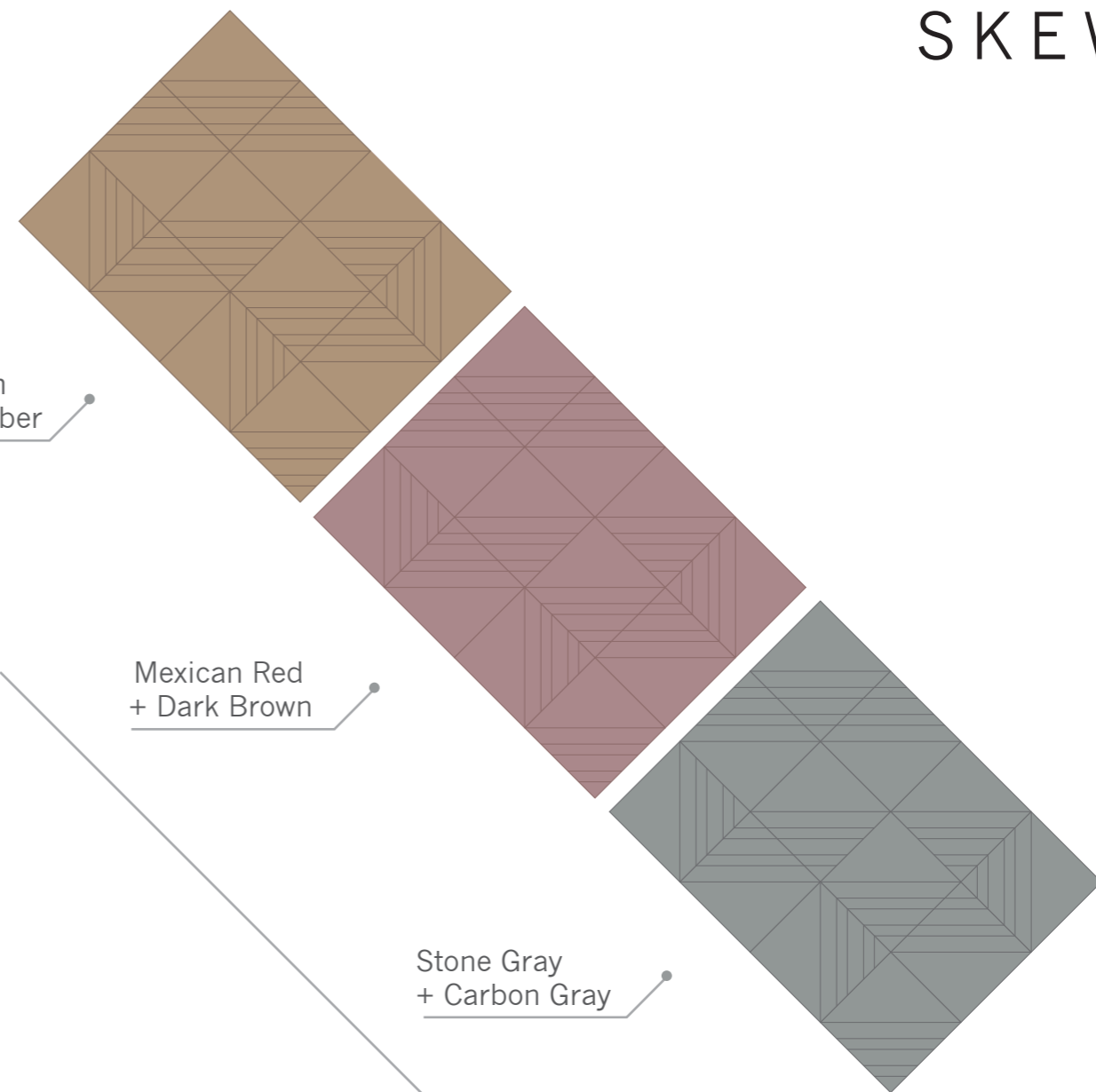

Rotation – alternate ascending & alternate descending order

Available in 25 different colours

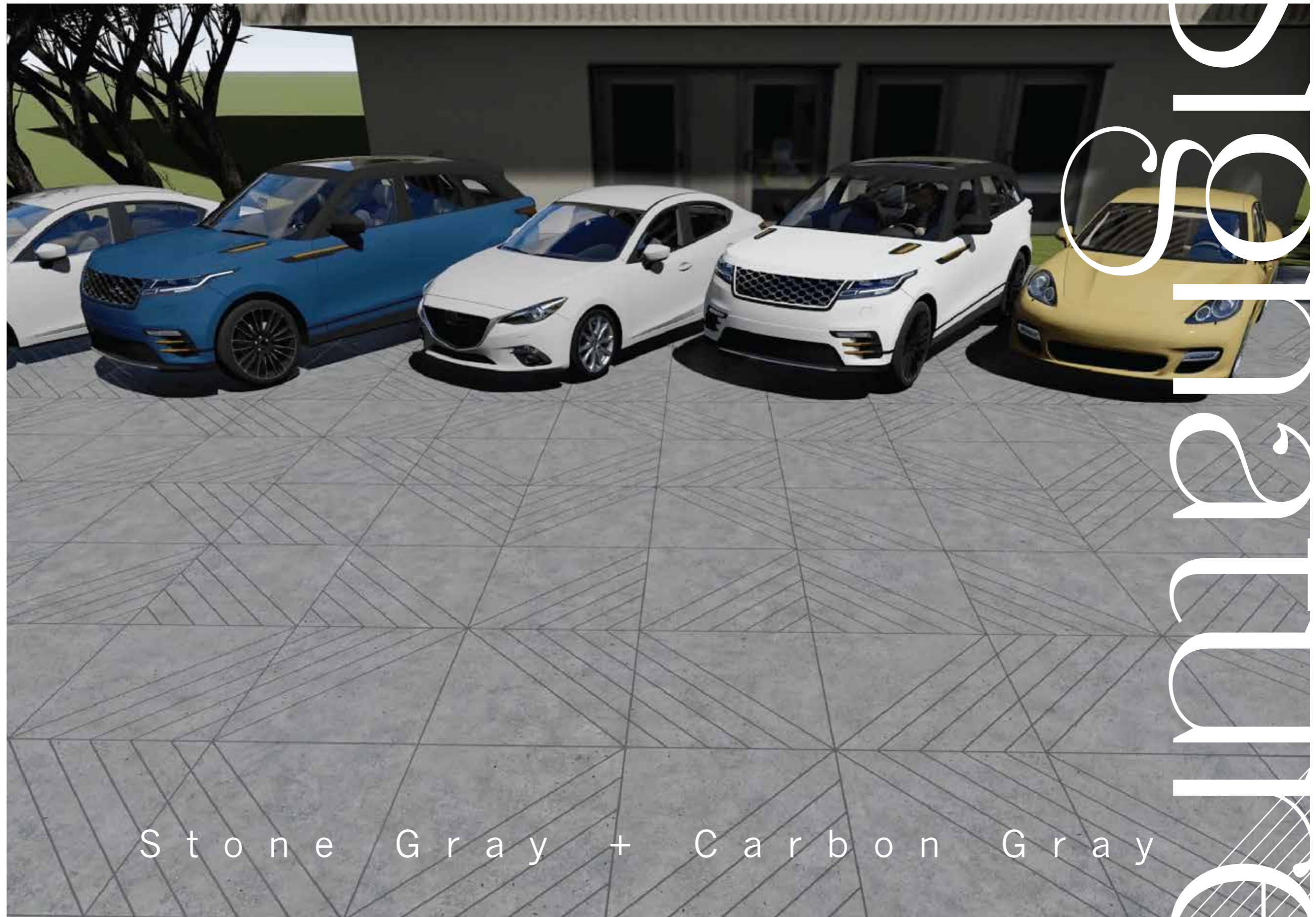

S t o n e   G r a y   +   C a r b o n   G r a y

SILVERLINE

# TRAVERSE LINE

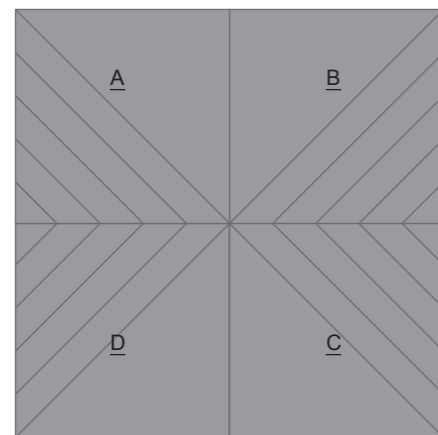
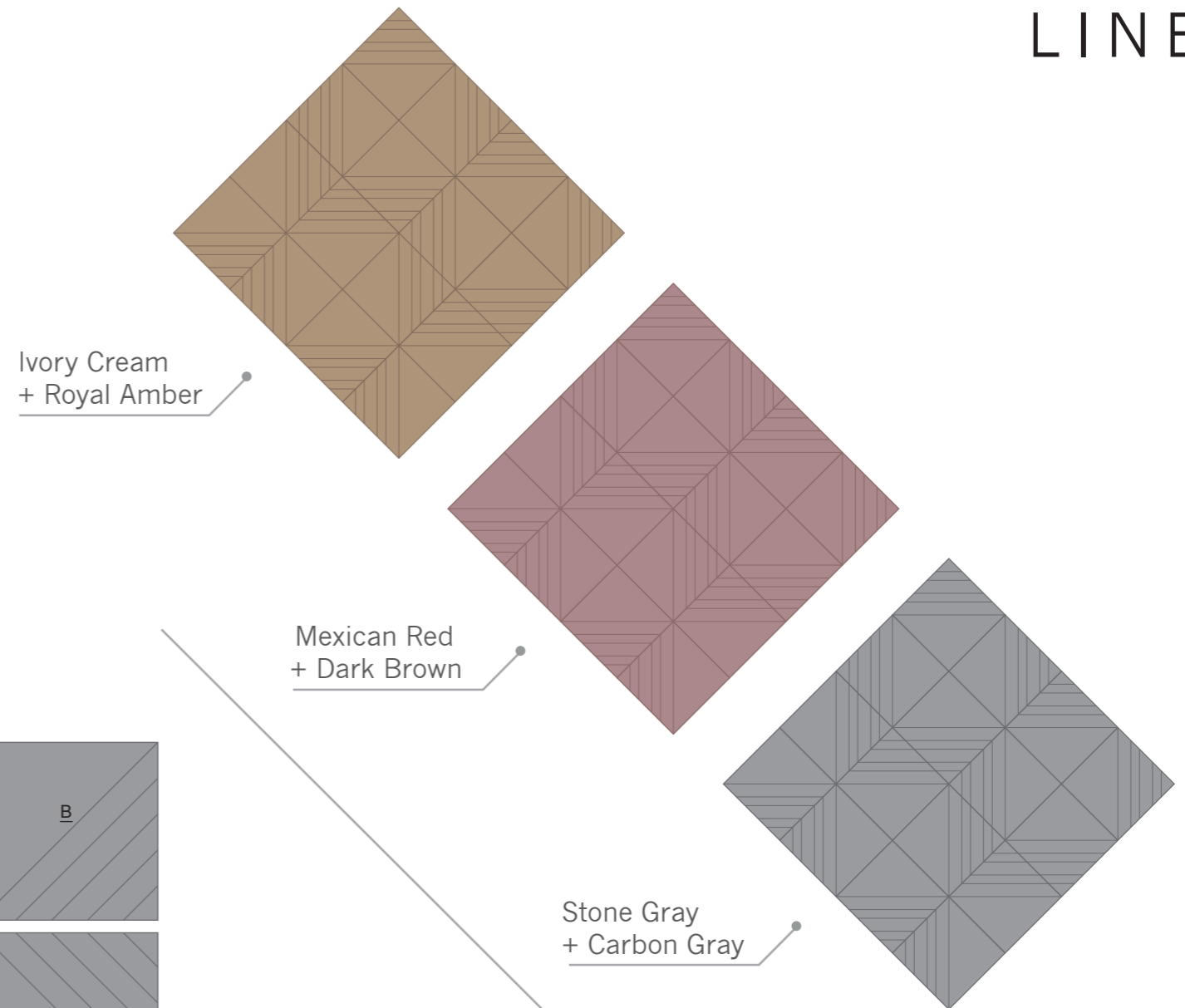
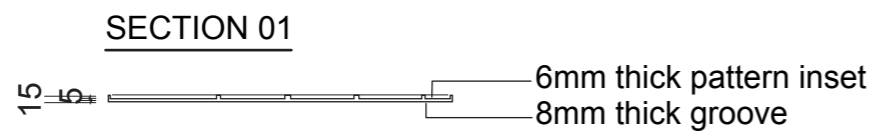
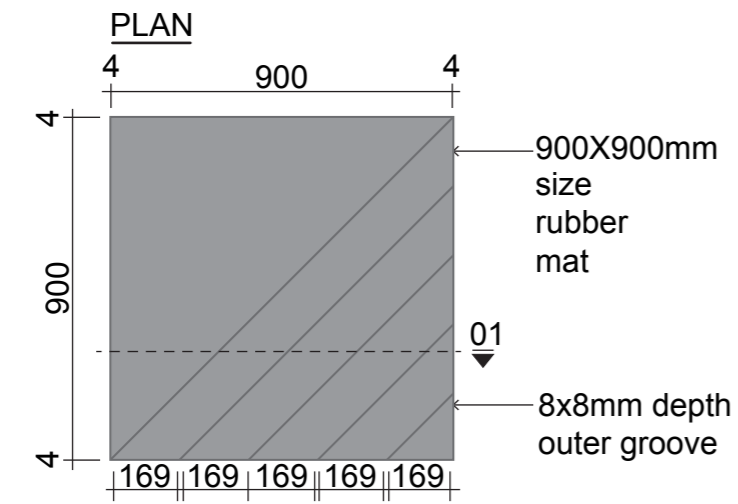

Method 01  
Showing the interlocking

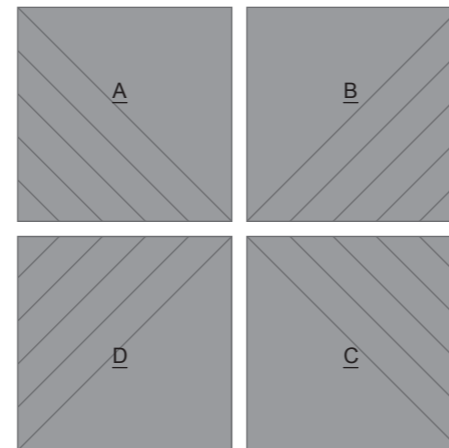

Method 02  
Showing the tessellation

Rotation – alternate ascending & alternate descending order

Available in 25 different colours

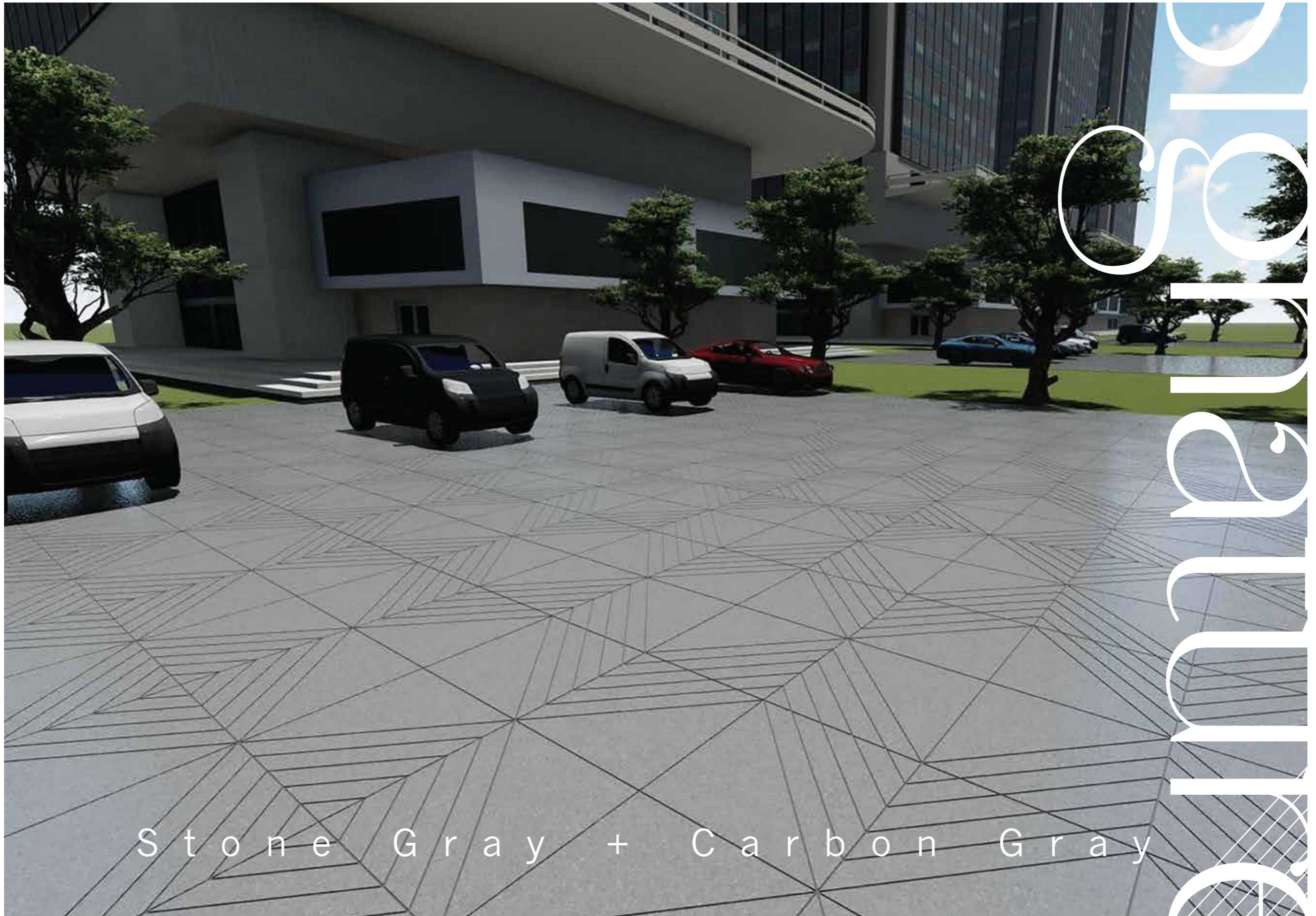

S t o n e G r a y + C a r b o n G r a y

Stone  
Carbon  
Gray

# ZIG ZAG PATTERN

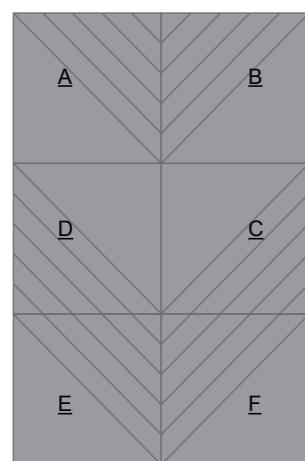
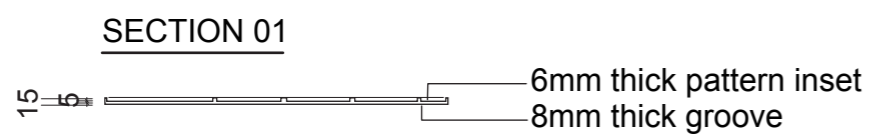
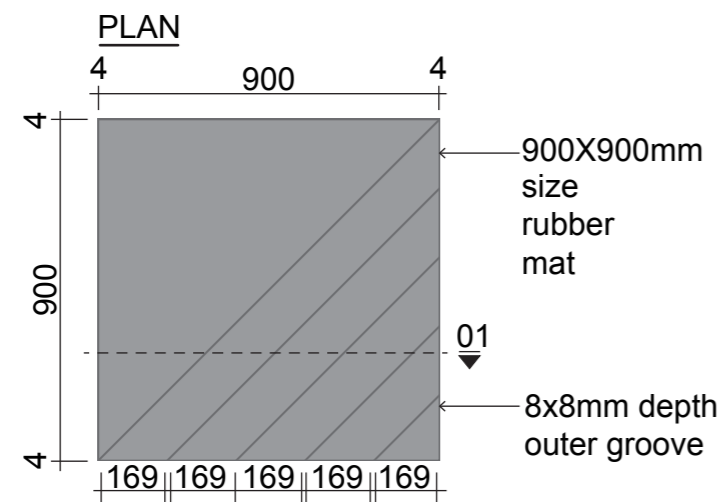

Method 01  
Showing the interlocking

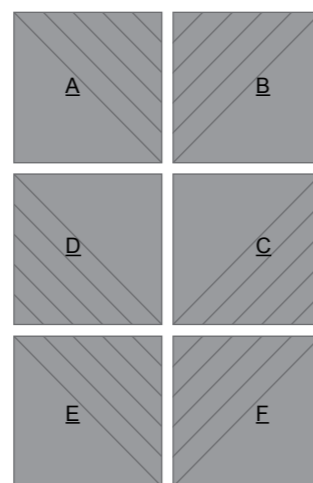

Method 02  
Showing the tessellation

Ivory Cream  
+ Royal Amber

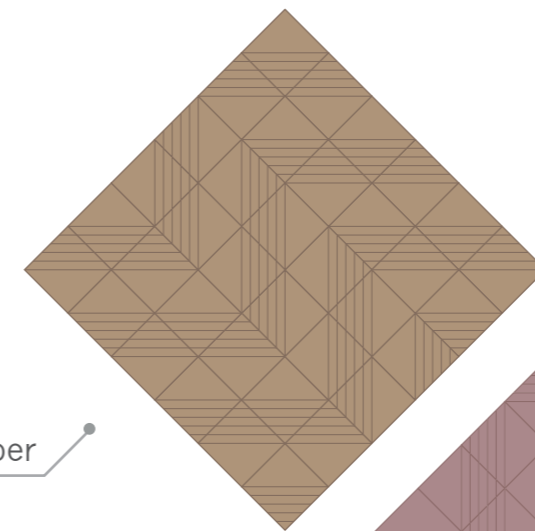

Mexican Red  
+ Dark Brown

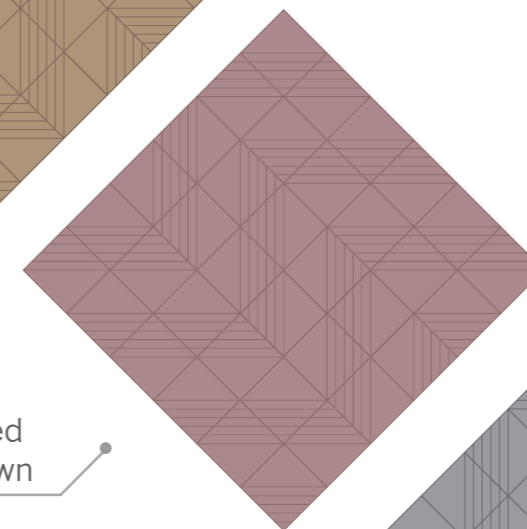

Stone Gray  
+ Carbon Gray

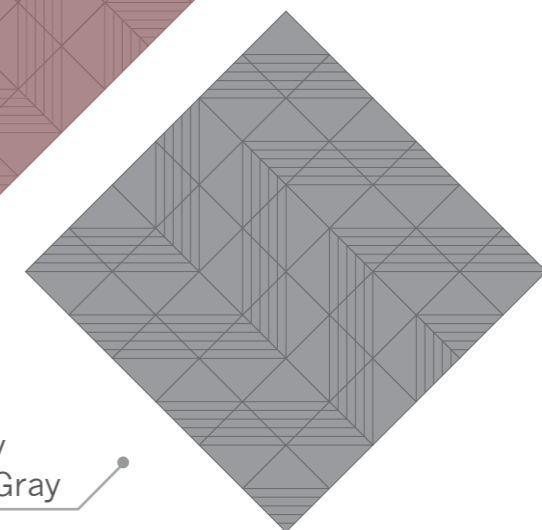

Rotation – alternate ascending & alternate descending order

Available in 25 different colours





Stone Gray + Carbon Gray

SILVER



# Artiste International



“Architecture is not  
about space. It’s about time.”  
– Vito Acconci

Every architect dreams of creating landmarks that do not get lost into oblivion. Every designer dreams of building structures that are applauded beyond geographical boundaries. The Artiste International Designs collection was created to make every such dream come true.

Inspired by the natural beauty of granite and stones, the International Designs collection offers unique and earthy patterns that are in tandem with the international trends. Taking elegance to a whole new level, these designs help to create architecture that stays unforgettable through time!

# CRAZY CUT ITALIAN SLATE

Royal Amber + Coral Pink

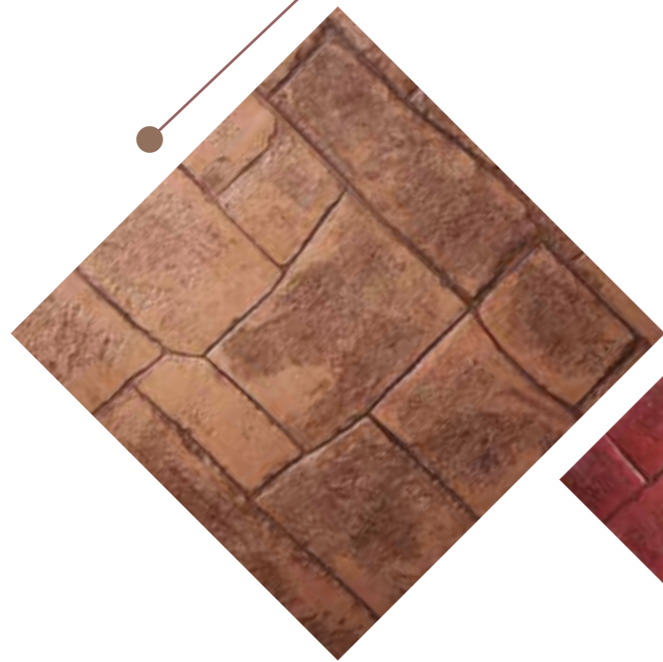

Brick Red + Coral Pink



Ash Gray + Stone Gray

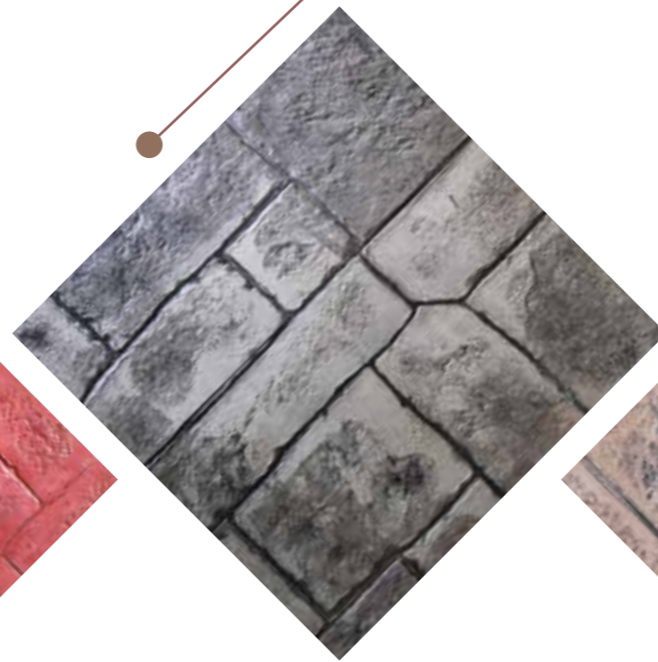

Royal Amber + Stone Gray

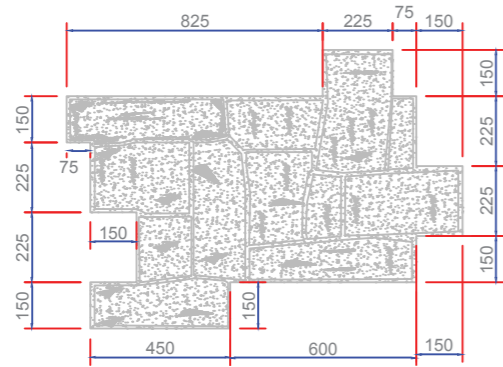

Crazy Cut Italian Slate

Mould Dimension

Available in 25 different colours

# Simulacrum



## CRAZY CUT ITALIAN SLATE



The designs in this pattern resemble stones laid in one of the oldest roads in Rome – The Via Appia. Medium irregular sized stones with a weathered texture and narrow precise joints highlight the quality of craftsmanship at that time.

# RUSTIC WOOD

Ash Gray + Stone Gray



Rock Brown + Carbon Gray



Royal Amber + Stone Gray



Sand Stone + Stone Gray

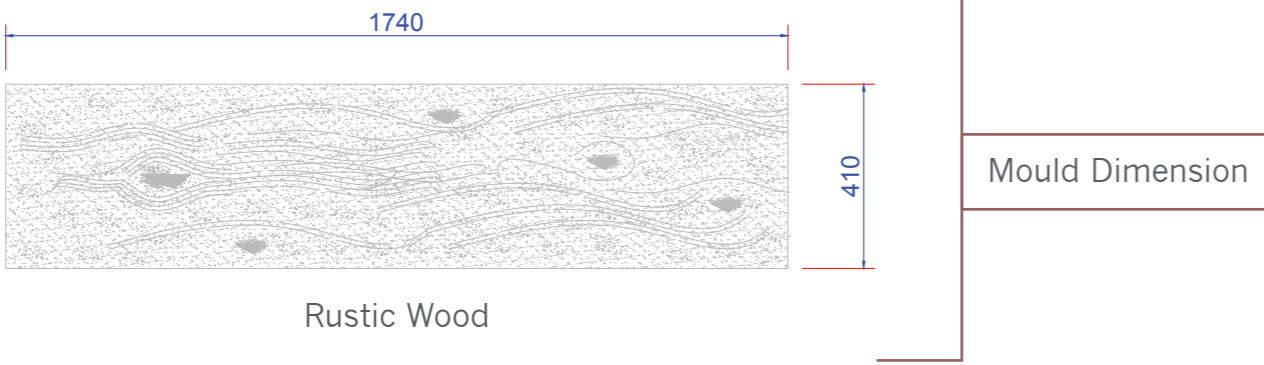

Rustic Wood

Available in 25 different colours

# Simulacrum

## RUSTIC WOOD

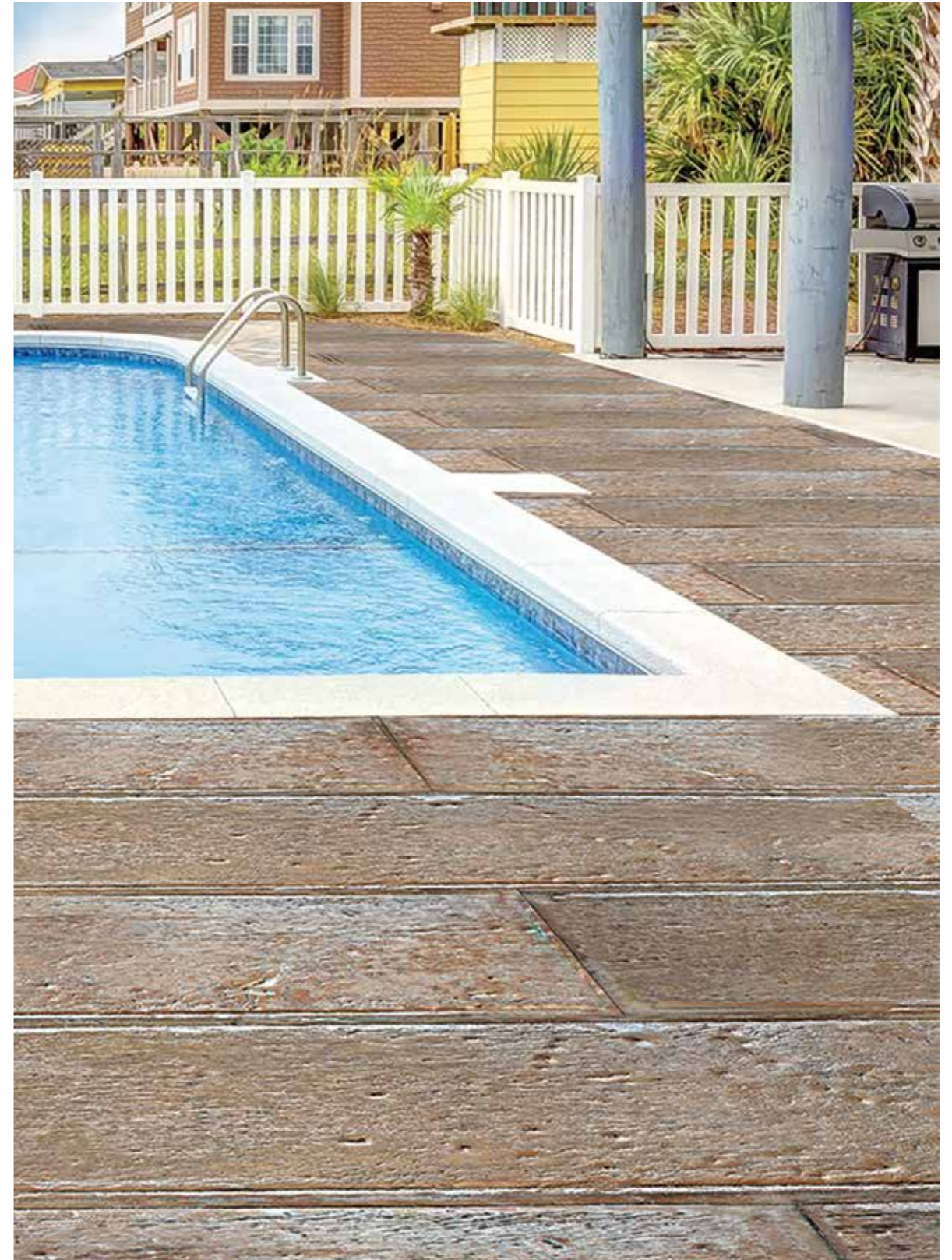

This unique wood pattern resembles a slow growing grained timber. Combined with bolt marks, this is very realistic looking texture that resembles wood flooring used in olden times.

# LARGE ANTICA COBBLE

Ash Gray + Carbon Gray



Ivory Cream + Coco Caramel



Royal Amber + Raisin Brown



Stone Gray + Stone Gray

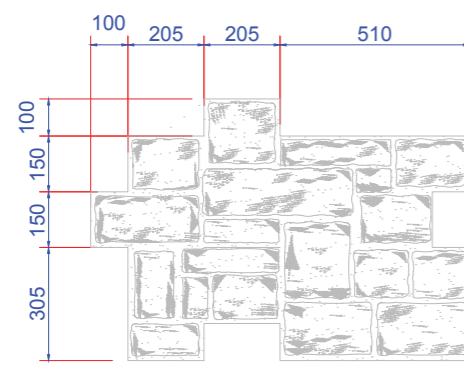

Large Antica Cobble

Mould Dimension

Available in 25 different colours



# Campanile



## LARGE ANTICA COBBLE

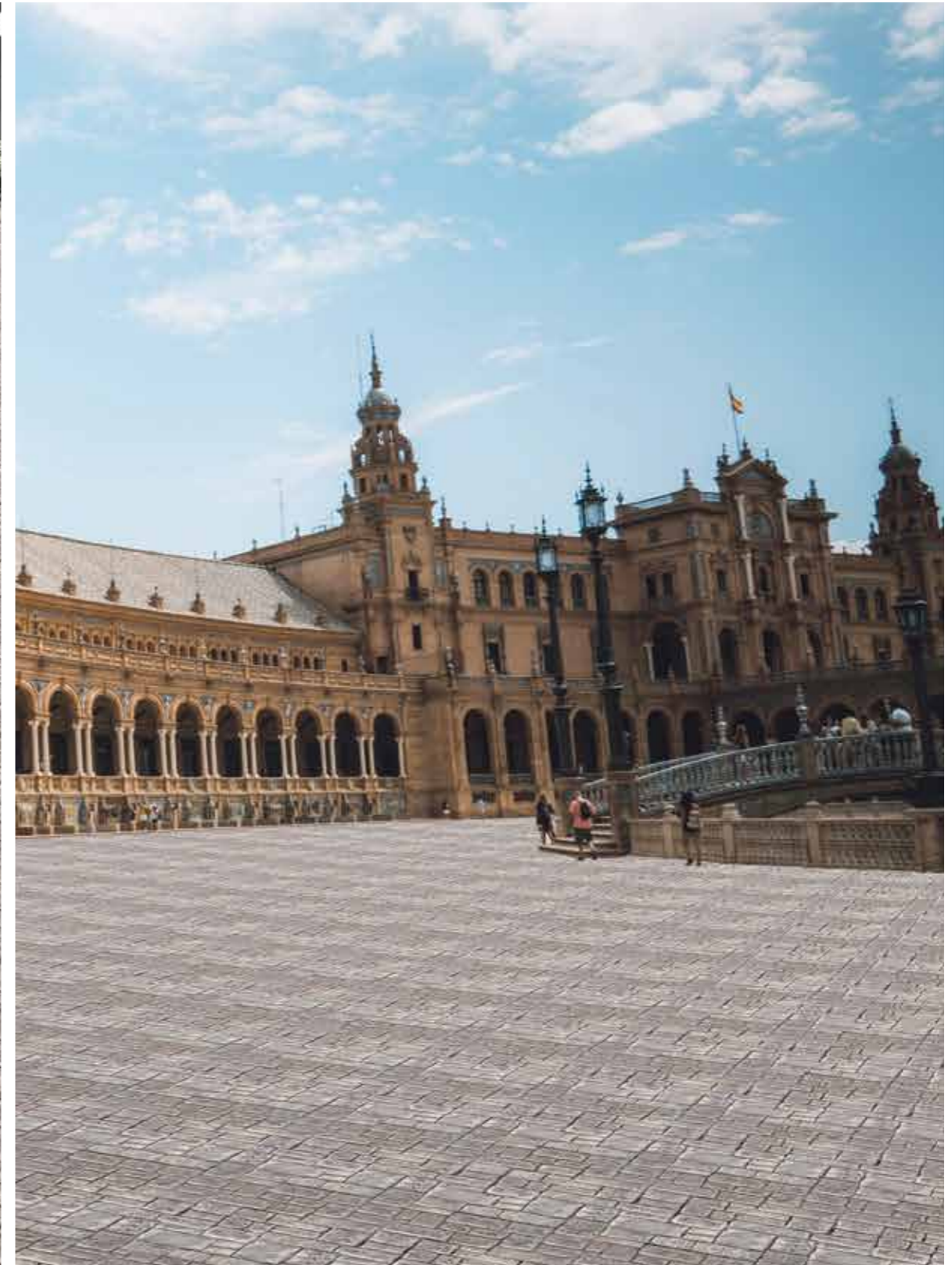

This pattern consists of a mixture of large and small cobblestones beautifully arranged in a random pattern. The stones have flat, irregular edges with small and large grooving. This pattern has tremendous amount of character and has been used in a variety of areas from Gardens to Pathways to Courtyards.

# TEMPLE GRANITE

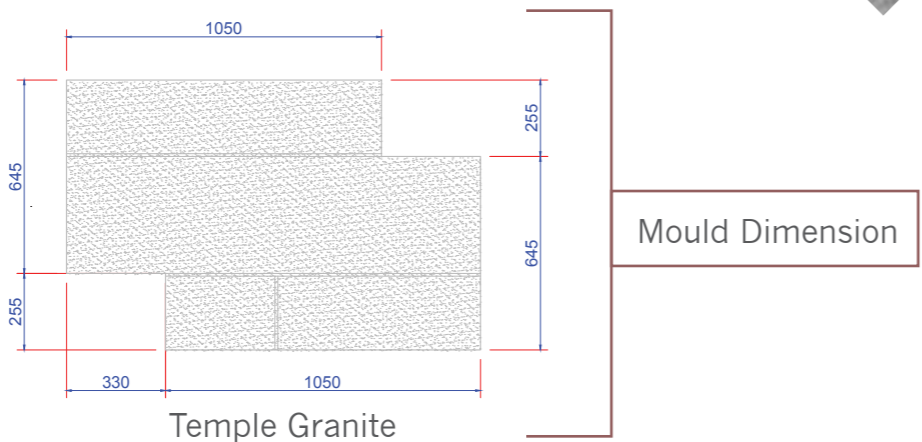
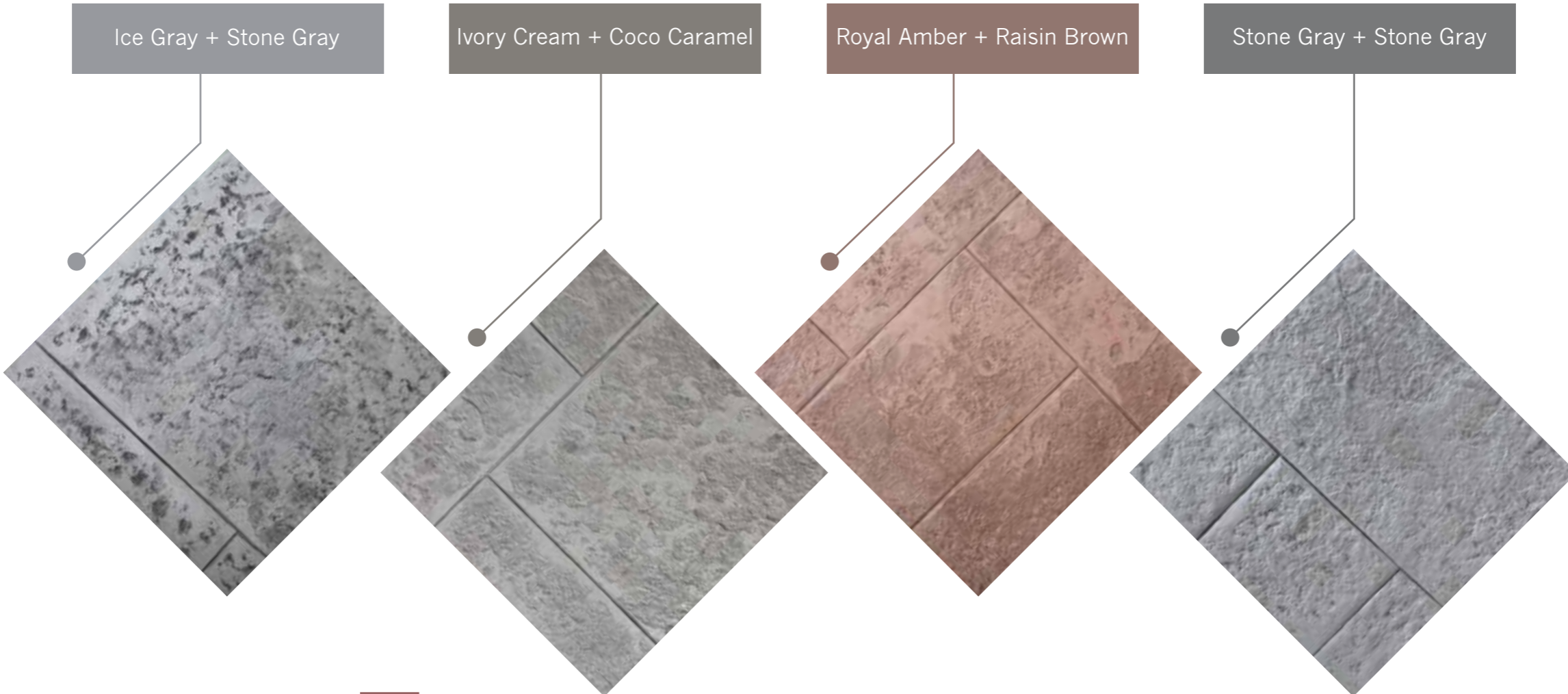

Available in 25 different colours

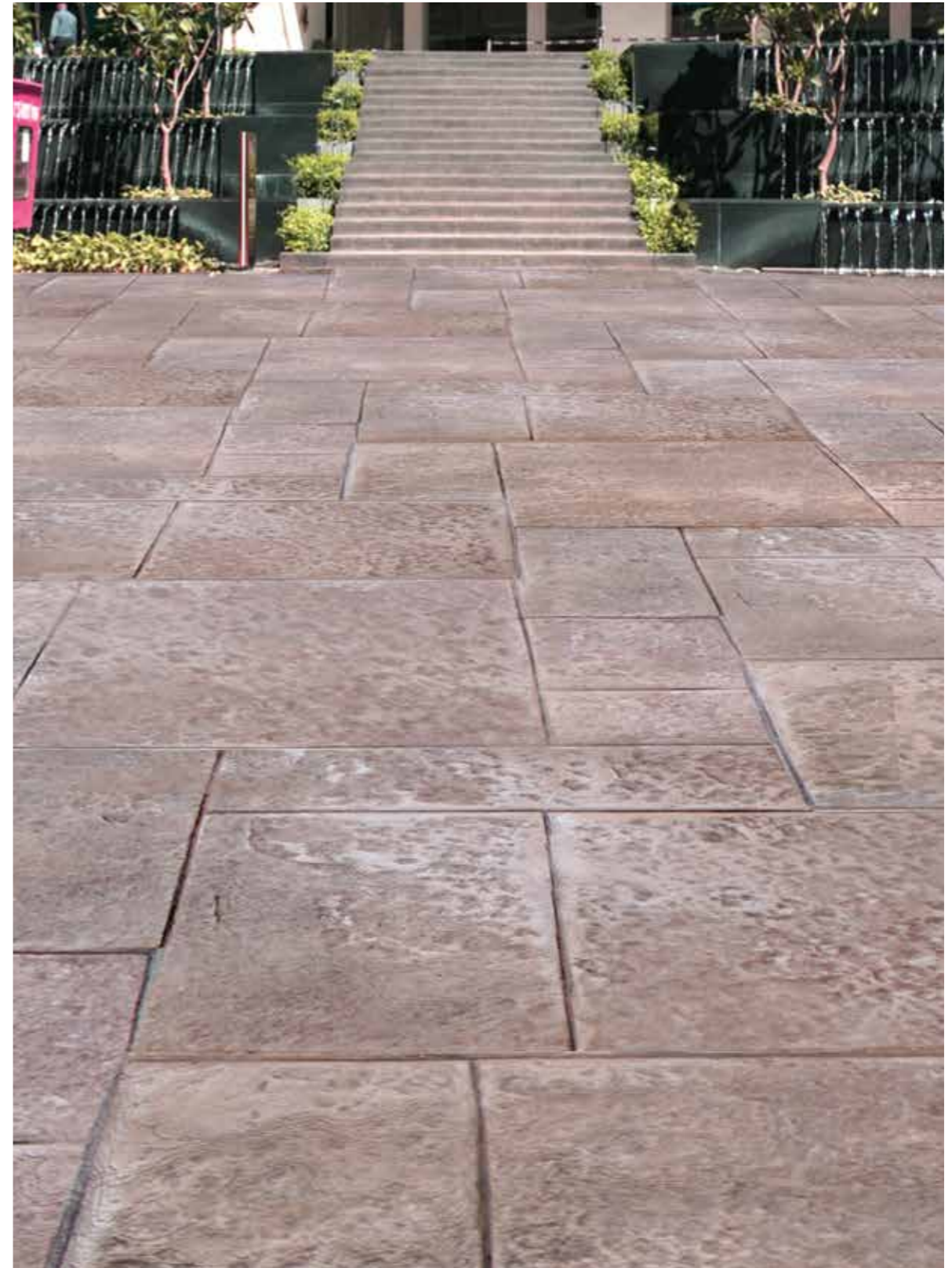

Large blocks of granite stone arranged in a random pattern with thin and minimal grooving. Granite is one of the most common stone flooring for large courtyards.

# TUMBLED GRANITE RUBBLE

Coral Pink + Raisin Brown

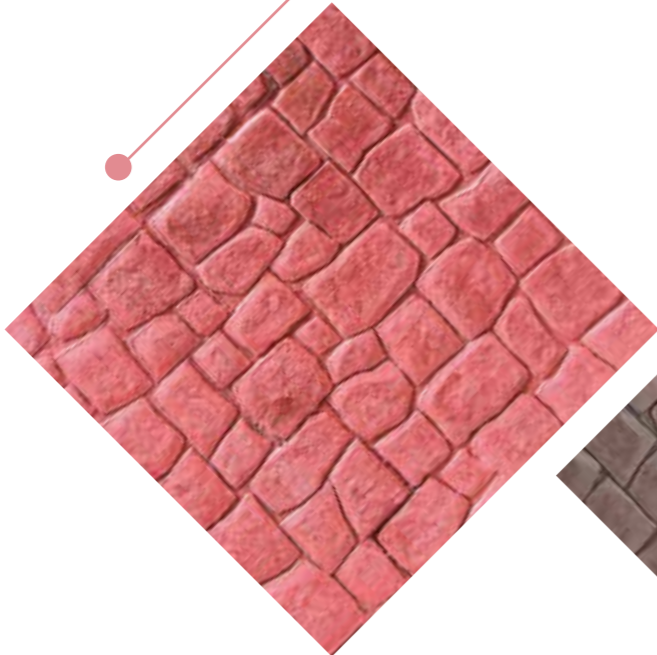

Creamy White + Coco Caramel

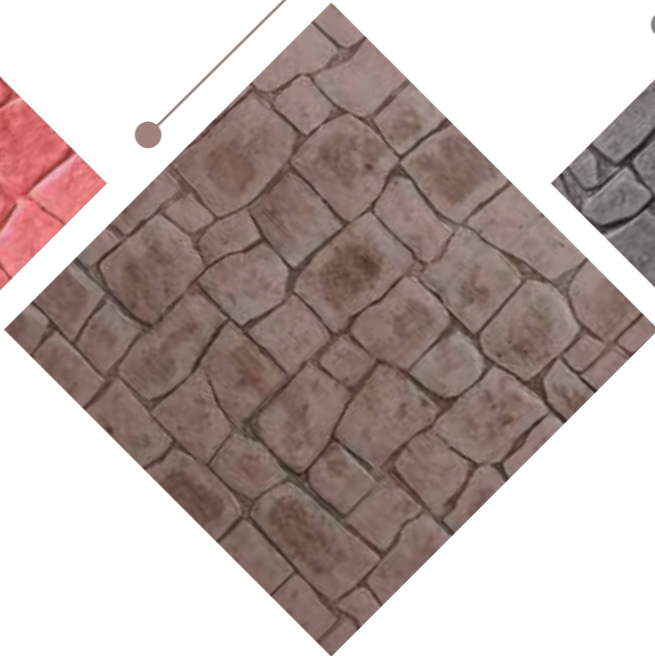

Ink Gray + Stone Gray



Royal Amber + Raisin Brown

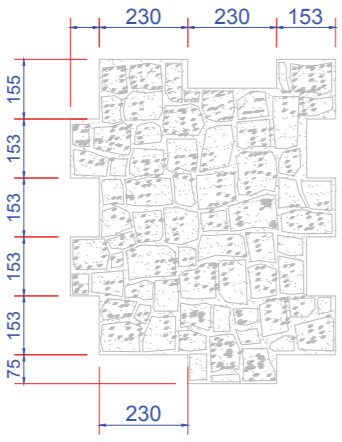
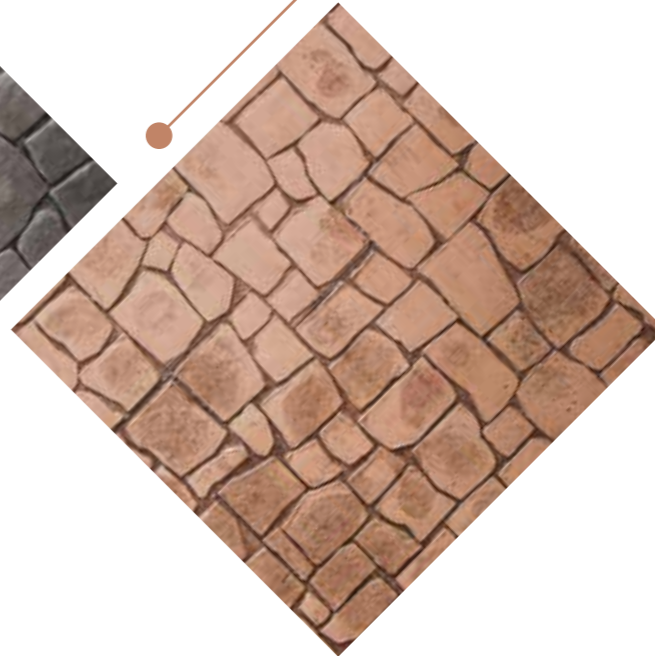

Mould Dimension

Tumbled Granite Rubble

Available in 25 different colours

TUMBLER GRANITE RUBBLE

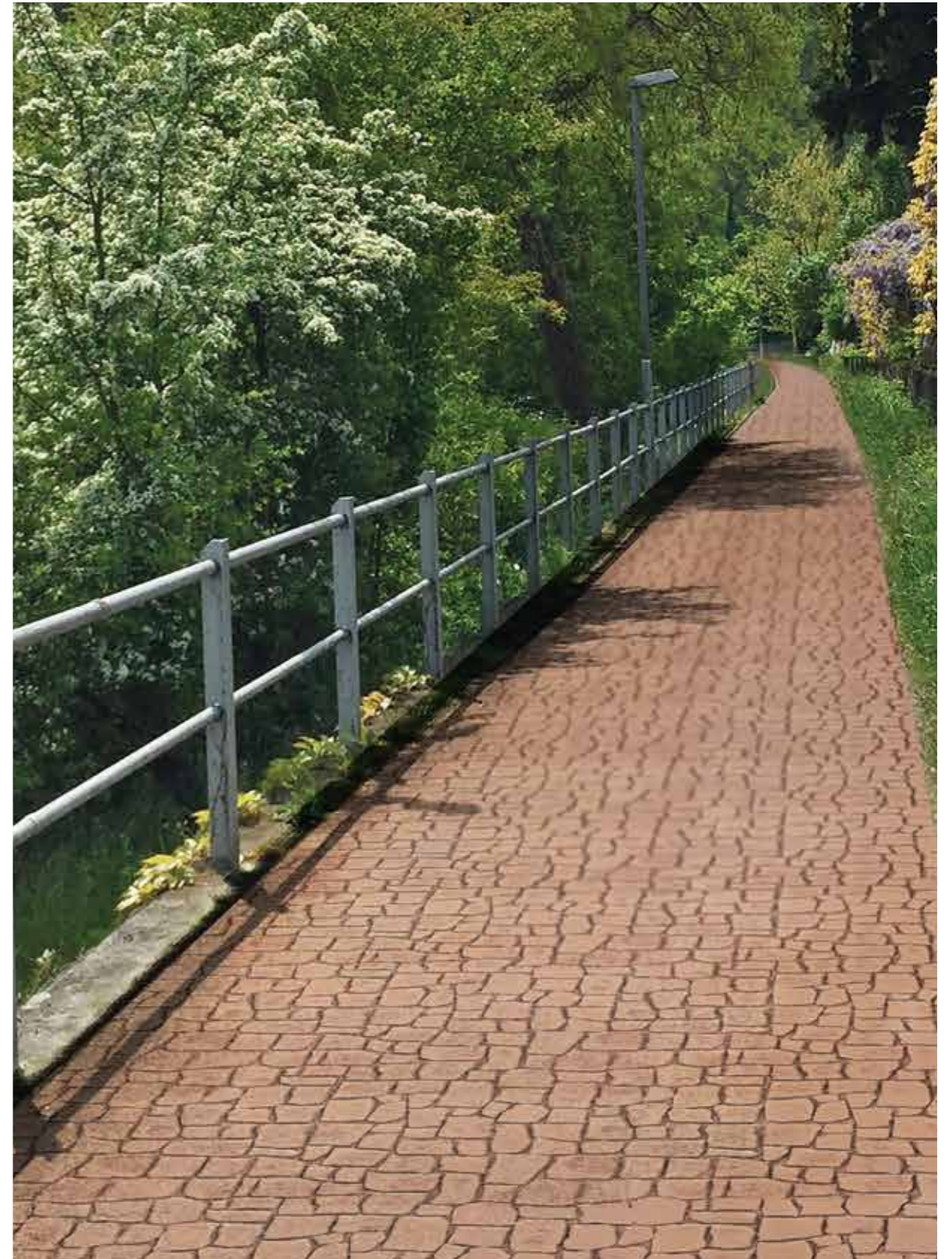

The small irregular sized stones with rounded corners resemble granite that has been carefully laid and naturally aged with time.

# SHADES

## Shade

Happy, euphoric, calm, pensive and much more – colours build up moods and evoke emotions. A reason why, we bring to you a palette of vibrant hues that reflect your emotions and personality. So, add a splash of colours to your home and let every corner speak your mind.

### GROUP A

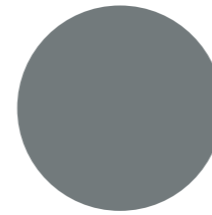

Stone Gray

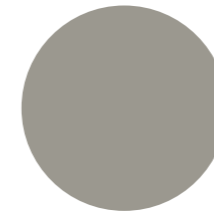

Ash Gray

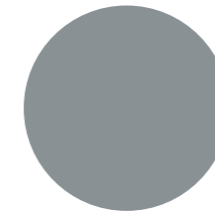

Ink Gray

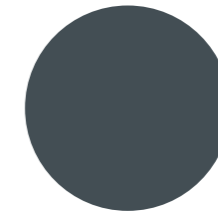

Carbon Gray

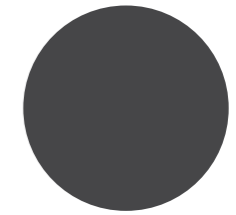

Brown Stone

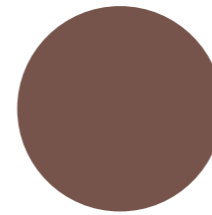

Dark Brown

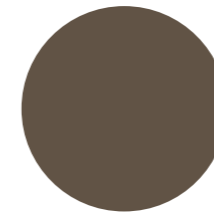

Wood Brown

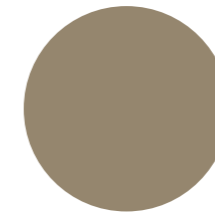

Rock Brown

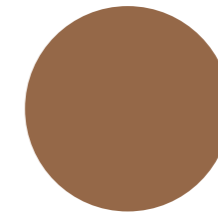

Teracotta

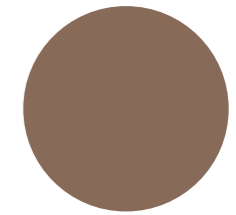

Raisin Brown

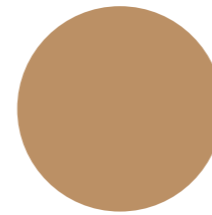

Royal Amber

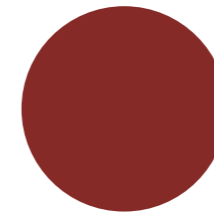

Mexican Red

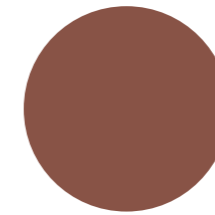

Brick Red

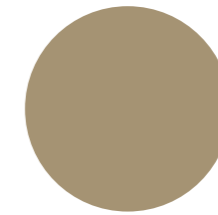

Limestone

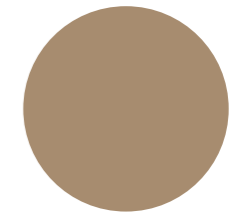

Coco Caramel

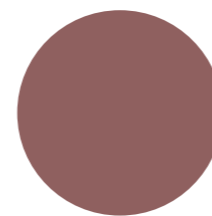

Grape Plum

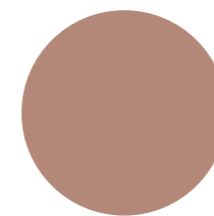

Coral Pink

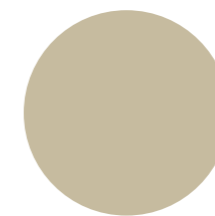

Sandstone

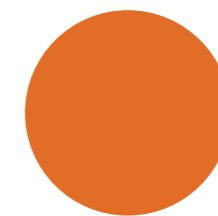

Dholpur Orange

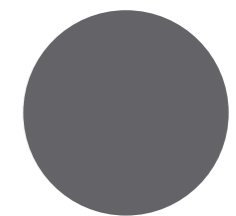

Lava Gray

### GROUP B



Creamy White

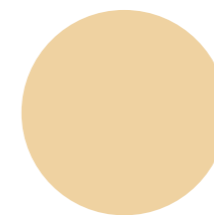

Ivory Cream

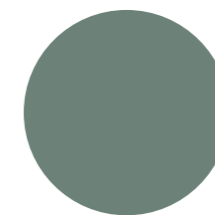

Cota Green

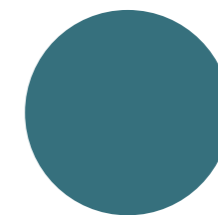

Belgian Blue

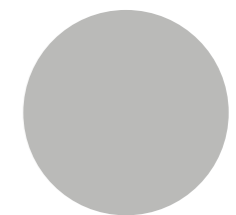

Ice Gray

## APPLICATION PROCESS

1 Laying  
Concrete



2 Broadcasting  
colour hardener



3 Stamping on  
Concrete



4 Application of  
Sealant

Estimated time required: 8 days

## DOs AND DON'Ts

### Dos

Complete your painting work before applying Artiste. The Artiste floor should be covered with a thick plastic sheet or POP, before any painting or other renovation work.

### Don'ts

Don't allow multiple vendors to work simultaneously, at site, at the time of the Artiste installation.

Don't allow anyone to drive on your new concrete driveway before 10-14 days of drying time.

Don't allow any foot and vehicular movement immediately after applying the sealer. There should be a gap of minimum 72 hrs after the sealer application.

Don't drag equipment or furniture on the stamped concrete. Sharp edges and the weight could scratch the sealer or chip the surface.

Don't use boring/hard-water for washing the stamped concrete surface.

### Disclaimer:

Shade colours and patterns are indicative, and may vary from actual colours and patterns. Ask for actual samples and installation process before finalisation.

## CLEANING & MAINTENANCE

### General Cleaning

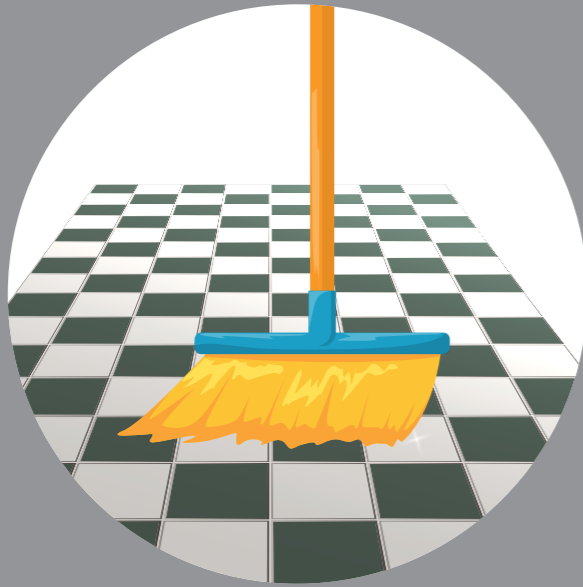

1) Sweep the surface with a broom



2) Wet-mop the surface and the grooves

### Addressing Tough Stains



1) Consider pressure-washing (120 bars) outdoor surfaces fortnightly/monthly



2) Try using a mild detergent

### Maintaining a Stamped Concrete Surface

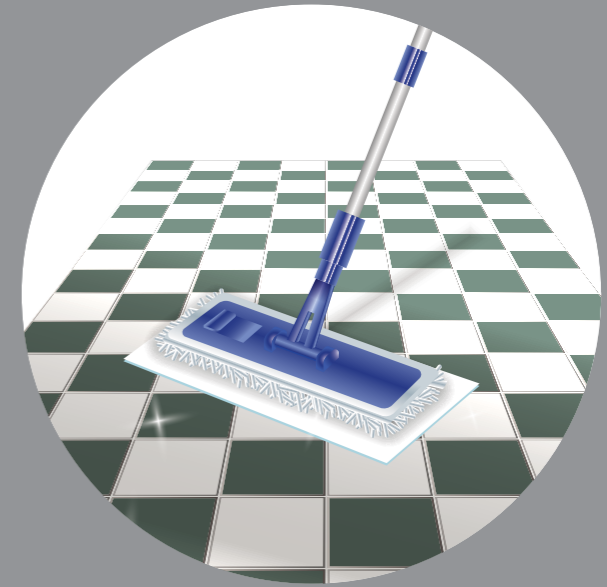

1) Sweep or dry dust-mop the surface weekly

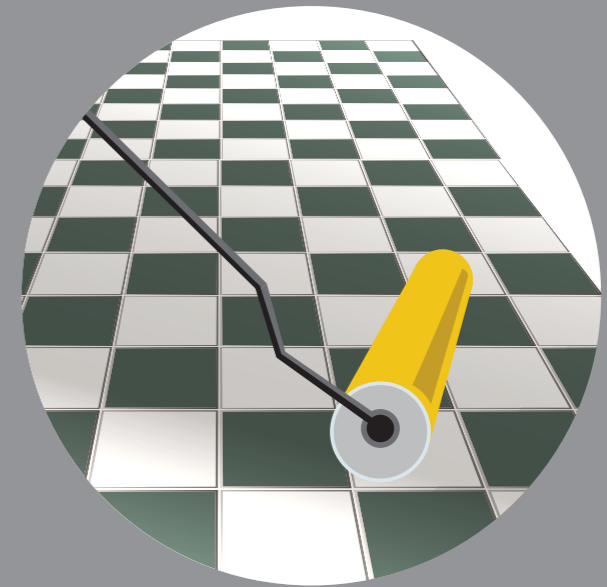

2) Reseal the surface every 2-3 years to protect its colour and help block dirt, dust and stains from penetrating and prevent wear and abrasion



## ARTISTE RANGE OF PRODUCT

### Artiste<sup>®</sup> Signature Collection Designer concrete

Artiste Signature comes in two variants – International Designs and Celebrity Designs. International designs are inspired by nature and natural beauty. Celebrity designs are created by none other than the well acclaimed interior designer Gauri Khan.

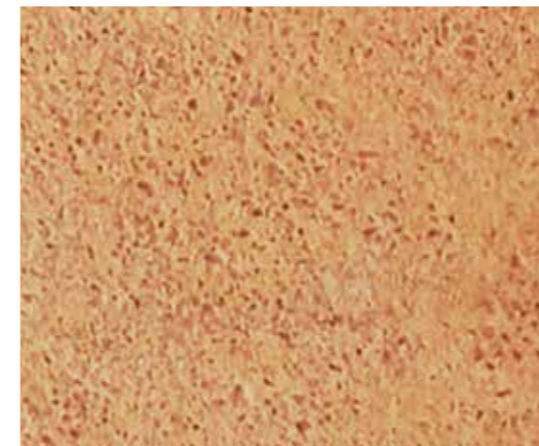

### Artiste<sup>®</sup> Coarse

Sand exposed concrete

Artiste Coarse feels like sand, remaining stable and dust free; whatever the weather. It is most preferred choice for landscaping, pathways, cycle and jogging tracks etc.

### Artiste<sup>®</sup> Engrave Stamp concrete

Artiste Engrave is a stamped concrete with an incredibly life like simulated paving, stone and natural finishes for heavy duty outdoor flooring application. They are durable, low maintenance and with proper care stay as beautiful as the day they were set, year after year.



### Artiste<sup>®</sup> Bare

Exposed Aggregate concrete

Artist Bare is a natural looking exposed aggregate concrete. It is a reliable and robust exterior flooring solution that can give you aesthetically pleasing finishes.



### Artiste<sup>®</sup> Lumos Glow Concrete

A premium landscape solution, the Artiste Lumos is a glow in the dark concrete which absorbs sunlight during the day and emits it back during the night, creating a visual marvel.

Used for glow paths, decks etc. Lumos is being used in the western countries and explored in the Middle East.

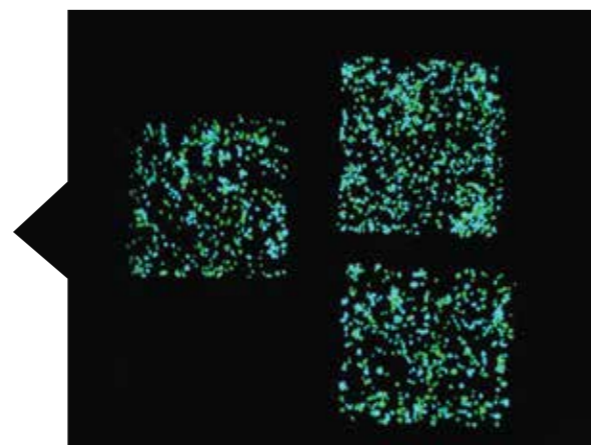

### Artiste<sup>®</sup> Hue

Colour concrete

Artiste Hue is a range of decorative concrete that comes in a broad palette of color tones providing finishes that can enhance the beauty and performance of the floor with minimum maintenance. It is widely used for warehouse and industrial flooring application.





Nuvoco Vistas Corp. Ltd. has been a part of the Indian construction landscape since 1999. We have an established presence across all major cities and towns in India. Our operations across three business divisions are:

Cement  
Ready Mix Concrete  
Modern Building Materials



Quality products of Nuvoco Vistas Corp. Ltd.



Equinox Business Park Tower-3, East Wing, 4th Floor,  
Off Bandra Kurla Complex, Kurla West, Mumbai - 400 070

Choose from our range of over 35 products:



Follow us on Nuvoco.com /Nuvoco @NuvocoVistas Toll Free: 1800 345 6666 WhatsApp 'NUVOCO' to 98300 17272